

---

## - AFTER SALES SERVICE

---

- Do not hesitate to contact your retailer or service agent if a change in the performance of your product indicates that a faulty condition may be present.



BN68-00883C-00

LCD TV LE26R51B/LE26R41B/LE32R51B/LE32R52B/LE32R41B/LE40R51B



# LCD TV

LE26R51B  
LE26R41B  
LE32R51B  
LE32R52B  
LE32R41B  
LE40R51B

## Owner's Instructions

Before operating the unit,  
please read this manual thoroughly,  
and retain it for future reference.

**ON-SCREEN MENUS  
PC DISPLAY  
PICTURE IN PICTURE (PIP)  
TELETEXT**

This device is a Class B digital apparatus.

Register your product at  
[www.samsung.com/global/register](http://www.samsung.com/global/register)

## Precautions When Displaying a Still Image

A still image may cause permanent damage to the TV screen.

- Digital Ready TV: When you select the regular screen (4:3) mode to watch an SD-grade digital broadcast (and the set-top box output is 480p).



- Digital Ready TV: When you select the wide screen (16:9) mode to watch an SD-grade digital broadcast (and the set-top box output is 1080i).

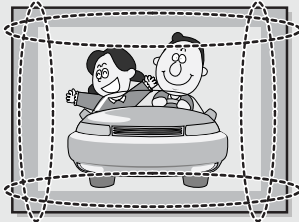

- Digital Ready TV: When the TV receives HD-grade signals (and the set-top box output is 1080i).

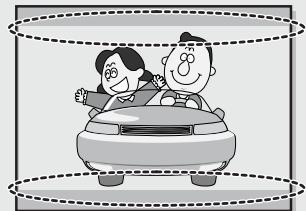

Although digital broadcasting must be in the wide screen (16:9) HD format, broadcasters sometimes show programs made originally in the regular screen format (4:3) by converting the signals into digital form, in which case the left and right side edges of the screen are cropped.

---

*Note : If the borders at the left, right and the center of the screen remain fixed for an extended period of time, the amount of light transmission will also remain varied and as a result the borders may leave traces.*

---

Do not leave the screen in pause mode for extended periods of time as you may experience temporary or permanent image burn.

When you watch a digital HD-grade broadcast on a regular (4:3) TV with the screen size "16:9" or "Panorama" selected, you will be able to watch the program but the top and bottom edges of the screen will be cropped.

---

*Note : If the borders at the top, bottom and the center of the screen remain fixed for an extended period of time, the amount of light transmission will also remain varied and as a result the borders may leave traces.*

---

Do not leave the screen in pause mode for extended periods of time as you may experience temporary or permanent image burn.

- Integrated Digital TV (Wide-screen): When the TV receives SD-grade (regular) broadcasting signals (receives 480p regular signals).
- Digital Ready TV (wide-screen): digital TV: When the TV receives SD-grade (regular) broadcasting signals (with a set-top box).
- When you watch an analog (regular) broadcast on a wide-screen TV (with the 4:3 screen mode selected).

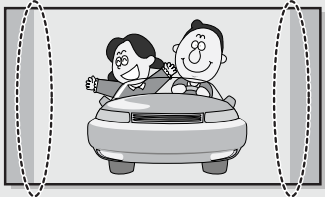

Although digital broadcasting must be in the wide screen (16:9) HD format, broadcasters sometimes show programs made originally in the regular screen format (4:3) by converting the signals into digital form, in which case the left and right side edges of the screen are cropped.

---

*Note : If the borders at the left, right and the center of the screen remain fixed for an extended period of time, the amount of light transmission will also remain varied and as a result the borders may leave traces.*

---

Do not leave the screen in pause mode for extended periods of time as you may experience temporary or permanent image burn.

- When you watch a DVD, CD or a video in wide-screen (21:9) format on a wide-screen (16:9) TV.
- When you connect a computer or a game console to the TV and select the 4:3 screen mode.

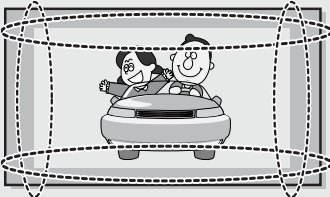

If you connect a DVD player, computer or a game console to the wide-screen TV and watch a movie or play a game in regular (4:3) or wide (21:9) screen mode, the left and right side edges, or the top and bottom edges of the screen will be cropped.

---

*Note : If the borders at the left, right and the center of the screen remain fixed for an extended period of time, the amount of light transmission will also remain varied and as a result the borders may leave traces.*

---

Do not leave the screen in pause mode for extended periods of time as you may experience temporary or permanent image burn.

# Contents

<b>◆ CONNECTING AND PREPARING YOUR TV</b>	
■ Viewing the Control Panel .....	4
■ Viewing the Connection Panel.....	5
- Connecting an Aerial or Cable Television Network .....	6
- Connecting Component Devices (DTV/DVD) .....	6
- Connecting External A/V Devices .....	6
- SERVICE .....	6
- Connecting Set-Top Box, VCR or DVD .....	6
- Connecting HDMI/DVI .....	7
- Connecting Computer .....	7
- Connecting AUDIO .....	7
- Kensington Lock .....	7
■ Viewing the Remote Control (All Functions Except Teletext) .....	8
■ Viewing the Remote Control (Teletext Functions).....	9
■ Installing Batteries in the Remote Control.....	10
■ Switching On and Off .....	11
■ Placing Your Television in Standby Mode .....	11
■ Becoming Familiar with the Remote Control .....	12
■ Plug and Play .....	13
■ Choosing Your Language .....	14
<b>◆ SETTING THE CHANNELS</b>	
■ Storing Channels Automatically .....	15
■ Storing Channels Manually.....	16
■ Editing the Channels .....	18
■ Sorting the Stored Channels .....	19
■ Assigning Channels Names .....	20
■ Fine Tuning Channel Reception .....	21
<b>◆ SETTING THE PICTURE</b>	
■ Changing the Picture Standard .....	22
■ Adjusting the Custom Picture .....	23
■ Changing the Colour Tone .....	24
■ Resetting the Picture Settings to the Factory Defaults .....	24
■ Changing the Picture Size .....	25
■ Freezing the Current Picture.....	25
■ Using the Digital NR (Digital Noise Reduction) Feature.....	26
■ DNle (Digital Natural Image engine) .....	27
■ My Colour Control .....	28
■ Dynamic Contrast.....	29
■ Brightness Sensor .....	30
■ Viewing the Picture In Picture (PIP) .....	31
<b>◆ SETTING THE SOUND</b>	
■ Adjusting the Volume .....	33
■ Switching the Sound Off Temporarily .....	34
■ Selecting the Sound Mode .....	34
■ Changing the Sound Standard .....	35
■ Adjusting the Sound Settings .....	35

# Contents

◆ <b>SETTING THE SOUND</b>	
■ Setting the TruSurround XT (SRS TSXT) .....	36
■ Adjusting the Volume Automatically .....	37
■ Connecting Headphones .....	38
■ Selecting the Internal Mute .....	38
■ Listening to the Sound of the Sub Picture .....	39
◆ <b>SETTING THE TIME</b>	
■ Setting and Displaying the Current Time .....	40
■ Setting the Sleep Timer .....	41
■ Switching the Television On and Off Automatically .....	42
■ Activating the Child Lock .....	43
◆ <b>SETTING THE OTHERS</b>	
■ Setting the Blue Screen Mode .....	44
■ Selecting the Melody .....	44
■ Selecting a Device from External Sources .....	45
■ Viewing Pictures from External Sources .....	46
◆ <b>SETTING THE PC</b>	
■ Setting up Your PC Software (Based on Windows XP) .....	47
■ Adjusting the PC Screen Automatically .....	48
■ Coarse and Fine Tuning of the Image .....	49
■ Changing the Image Position .....	50
■ Initializing the Image Settings .....	51
◆ <b>USING THE TELETEXT FEATURE</b>	
■ Teletext Decoder .....	52
■ Displaying the Teletext Information .....	52
■ Selecting a Specific Teletext Page .....	53
■ Using Fastext to Select a Teletext Page .....	54
◆ <b>RECOMMENDATIONS FOR USE</b>	
■ Troubleshooting: Before Contacting Service Personnel .....	55
■ Installing the Wall Mount Kit (LE26R51B, LE26R41B) .....	56
■ Installing the Wall Mount Kit (L E32R51B, LE32R52B, LE32R41B, LE40R51B) .....	58
■ Installing the Stand (L E26R51B, LE26R41B, LE32R51B, LE32R52B, LE32R41B) .....	60
■ Using the Anti-Theft Kensington Lock .....	61
■ Technical and Environmental Specifications .....	62
■ Display Mode (PC) .....	63
■ Pin Configurations .....	64
■ Wiring the Mains Power Supply Plug (UK Only) .....	65

## Symbols



# Viewing the Control Panel

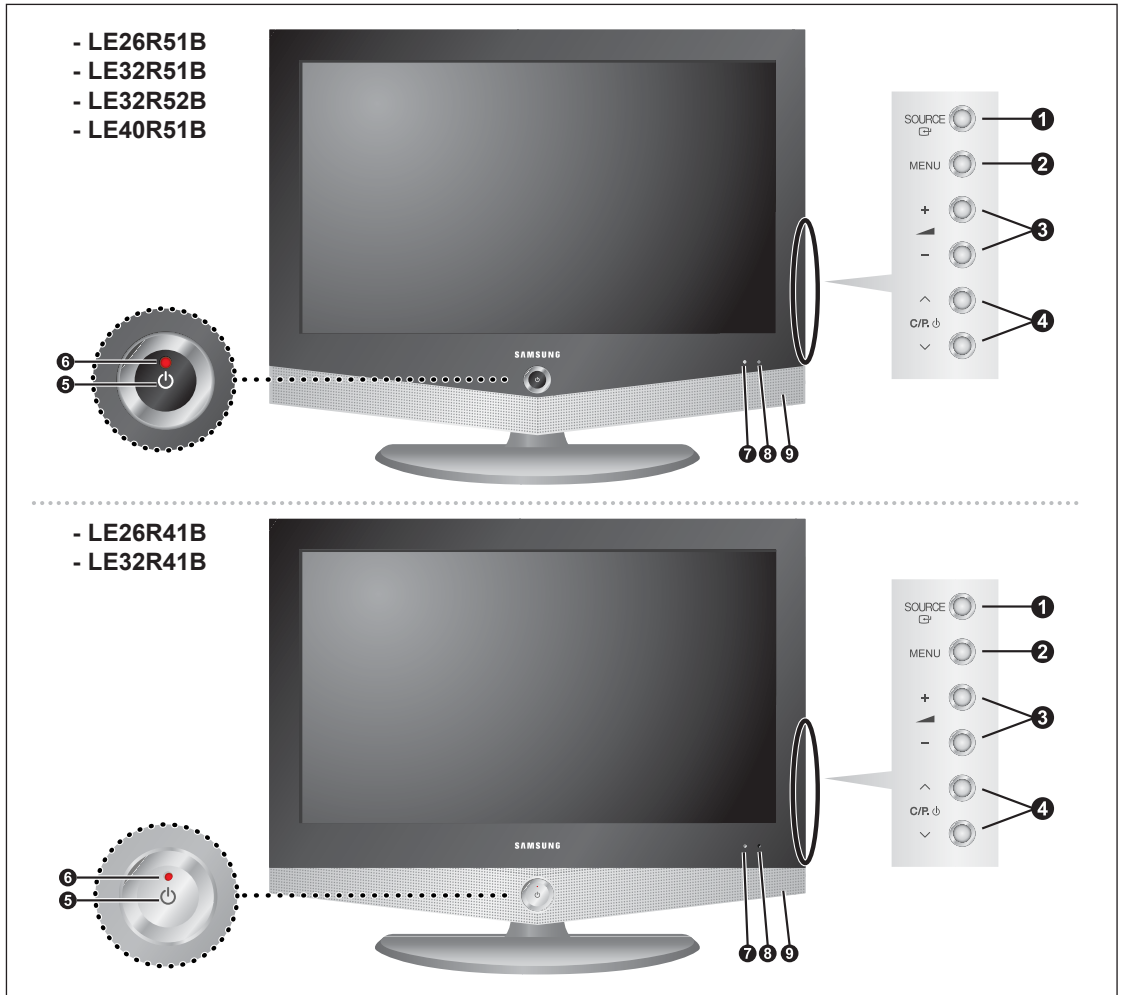

## 1 SOURCE

Displays a menu of all of the available input sources (TV, Ext. 1, Ext. 2, AV, S-Video, Component, PC, HDMI). You can also use the SOURCE  button on the TV's control panel to make selections.

## 2 MENU

Press to see an on-screen menu of your TV's features.

## 3 - +

Press to decrease or increase the volume. Also used to select items on the on-screen menu.

## 4 C/P

Press to change channels. Also press to highlight various items on the on-screen menu. (Without the Remote Control, You can turn on TV by using the Channel buttons.)

## 5 (Power)

Press to turn the TV on and off.

## 6 Power Indicator

Blinks and turns off when the power is on and lights up in stand-by mode.

## 7 Light Detecting Sensor

Adjusts brightness of screen automatically by detecting brightness of surrounding environment. This sensor works when Brightness Sensor is on.

## 8 Remote Control Sensor

Aim the remote control towards this spot on the TV.

## 9 Speakers

# Viewing the Connection Panel

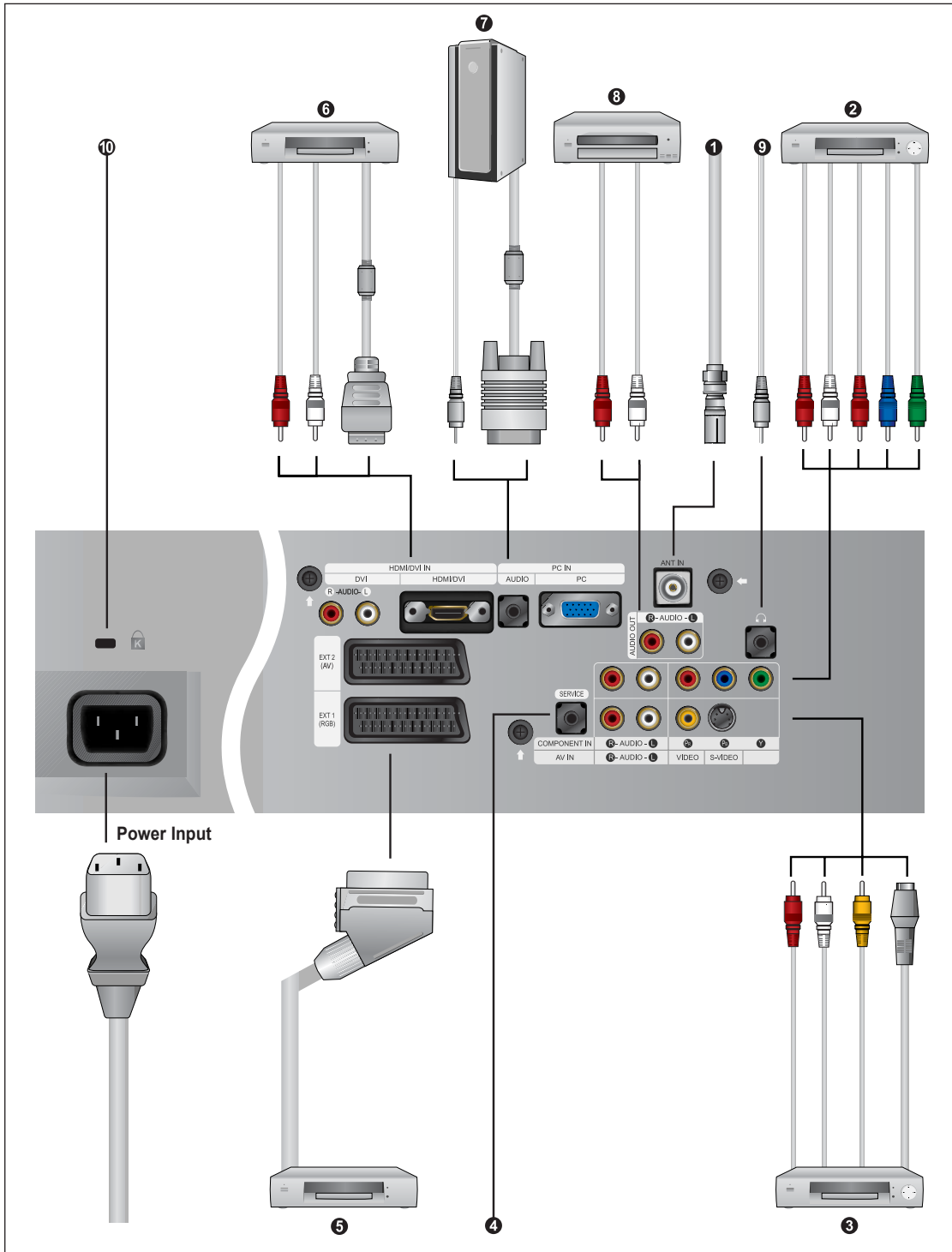

Whenever you connect an audio or video system to your set, ensure that all elements are switched off.

# Viewing the Connection Panel

## ① Connecting an Aerial or Cable Television Network

To view television channels correctly, a signal must be received by the set from one of the following sources:

- An outdoor aerial
- A cable television network
- A satellite network

## ② Connecting Component Devices (DTV/DVD)

- Connect component video cables to component connector ("Pr", "Pb", "Y") on the rear of your set and the other ends to corresponding component video out connectors on the DTV or DVD.
- If you wish to connect both the Set-Top Box and DTV (or DVD), you should connect the Set-Top Box to the DTV (or DVD) and connect the DTV (or DVD) to component connector ("Pr", "Pb", "Y") on your set.
- The Y, Pb and Pr connectors on your component devices (DTV or DVD) are sometimes labeled Y, B-Y and R-Y or Y, Cb and Cr.
- Connect RCA audio cables to "R - AUDIO - L" on the rear of your set and the other ends to corresponding audio out connectors on the DTV or DVD.

## ③ Connecting External A/V Devices

- Connect RCA or S-VIDEO cable to an appropriate external A/V device such as VCR, DVD or Camcorder.
- Connect RCA audio cables to "R - AUDIO - L" on the rear of your set and the other ends to corresponding audio out connectors on the A/V device.
- Headphone may be connected to the headphone output ( 9 ) on the rear of your set. While the headphone is connected, the sound from the built-in speakers will be disabled.

## ④ SERVICE

- Connector for engineer.

## ⑤ Connecting Set-Top Box, VCR or DVD

- Connect the VCR or DVD SCART cable to the SCART connector of the VCR or DVD.
- If you wish to connect both the Set-Top Box and VCR (or DVD), you should connect the Set-Top Box to the VCR (or DVD) and connect the VCR (or DVD) to your set.

### ➤ Input/Output Specification

Connector	Input				Output
	Video	Audio (R/L)	S-Video	RGB	Video+Audio (R/L)
SCART 1 (EXT 1)	✓	✓		✓	Only TV Out
SCART 2 (EXT 2)	✓	✓			Monitor Out (TV/Ext. 1/Ext. 2/AV/S-VHS)



# Viewing the Connection Panel

## 6 Connecting HDMI/DVI

- Supports connections between HDMI-connection-enabled AV devices (set top boxes, DVD players, AV receivers and digital TVs).
- No sound connection is needed for an HDMI to HDMI connection.

### ➤ What is HDMI?

- HDMI, or high-definition multimedia interface, is a next-generation interface that enables the transmission of digital audio and video signals using a single cable without compression.
- “Multimedia interface” is a more accurate name for it especially because it allows multiple channels of digital audio (5.1 channels). The difference between HDMI and DVI is that the HDMI device is smaller in size, has the HDCP (High Bandwidth Digital Copy Protection) coding feature installed, and supports multi - channel digital audio.
- Use the HDMI/DVI terminal for DVI connection to an extended device.

➤ You should use the DVI-to-HDMI cable or DVI-HDMI Adapter for the connection, and the “R - AUDIO - L” terminal on DVI for sound output.

## 7 Connecting Computer

- Connect the D- Sub cable to “PC (PC IN)” on the rear of your set and the other end to the Video Card of your computer.
- Connect the stereo audio cable to “AUDIO (PC IN)” on the rear of your set and the other end to “Audio Out” of the sound card on your computer.

## 8 Connecting AUDIO

- Connect RCA audio cables to “R - AUDIO - L” on the rear of your set and the other ends to corresponding audio in connectors on the Amplifier or DVD Home Theater.

	Speaker			SCART2 Out & Audio Out		
	RF	Scart, AV, S-Video	Component, PC, HDMI	RF	Scart, AV, S-Video	Component, PC, HDMI
Internal Mute Off	Speaker Output	Speaker Output	Speaker Output	Sound Output	Sound Output	Sound Output
Internal Mute On	Mute	Mute	Mute	Sound Output	Sound Output	Sound Output
Video No Signal	Mute	Mute	Mute	Mute	Sound Output	Sound Output

## 10 Kensington Lock

- Refer to “Using the Anti-Theft Kensington Lock” on page 61.



< LE32R51B / LE32R52B / LE32R41B >



< LE26R51B / LE26R41B / LE40R51B >

# Viewing the Remote Control (All Functions Except Teletext)

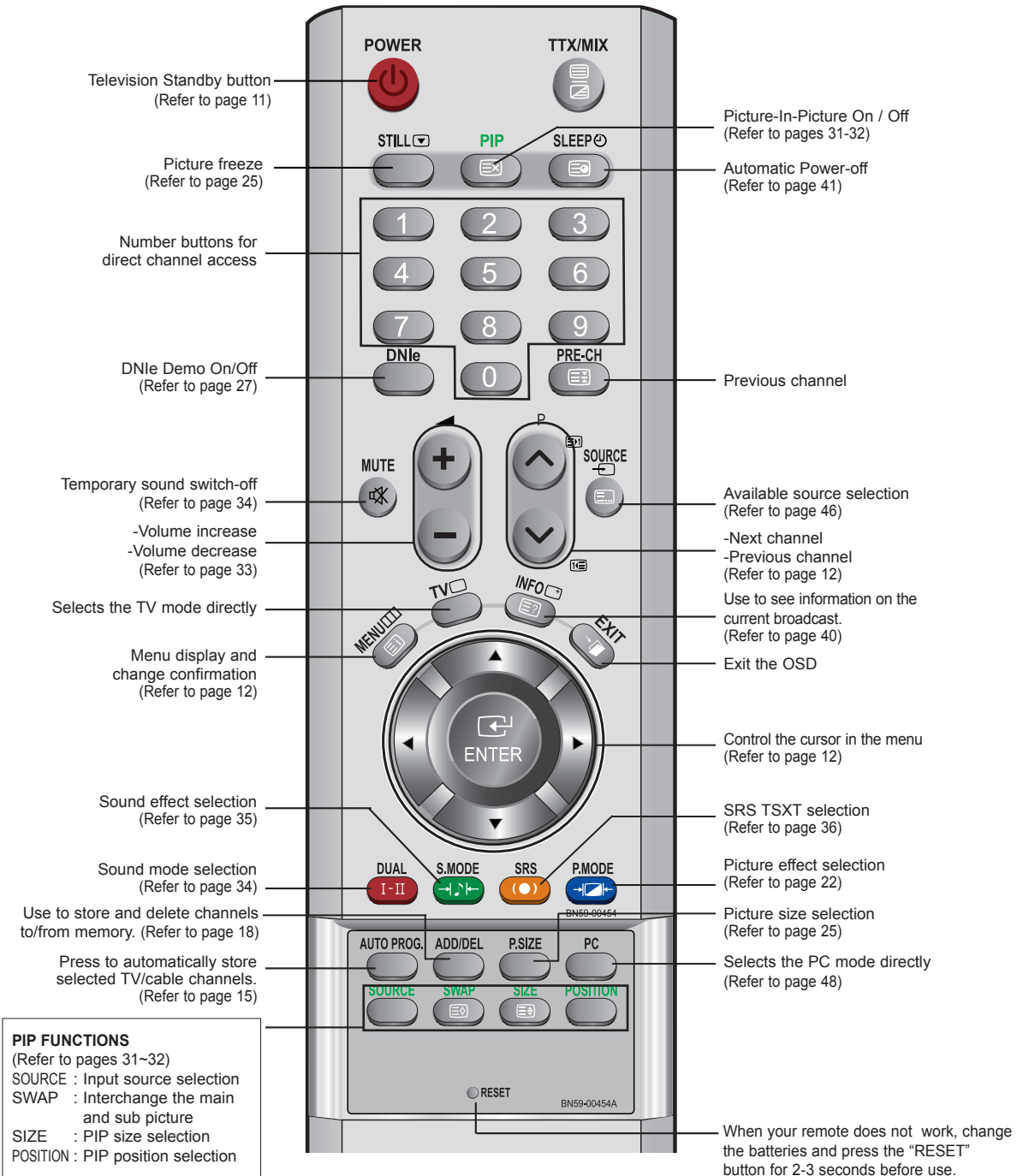

➤ The performance of the remote control may be affected by bright light.

# Viewing the Remote Control (Teletext Functions)

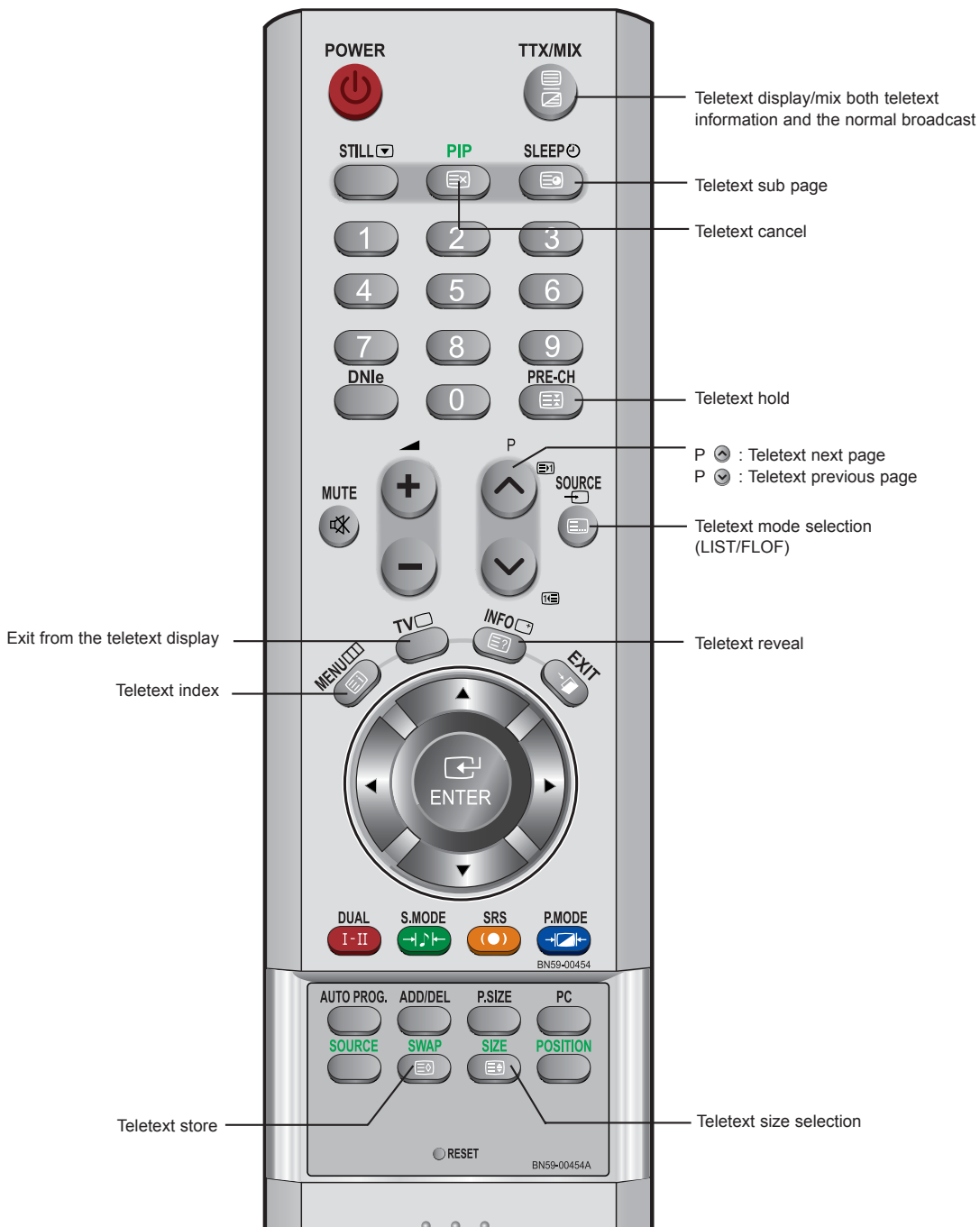

➤ Teletext Function : Refer to pages 52-54 for details

## Installing Batteries in the Remote Control

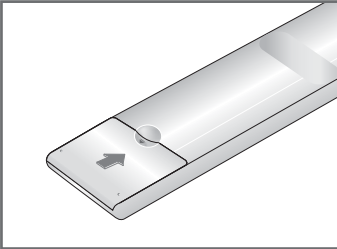
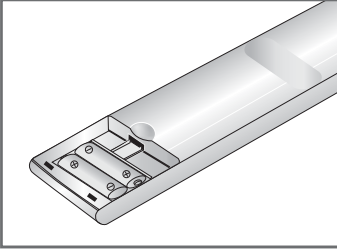
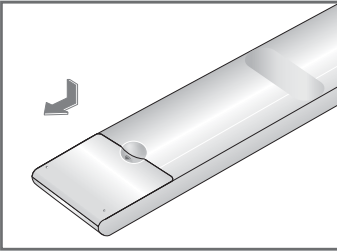

---

**1** Slide the cover out completely.

---

**2** Install two AAA size batteries.

➤ Make sure to match the “+” and “-” ends of the batteries with the diagram inside the compartment.

---

**3** Replace the cover.

➤ Remove the batteries and store them in a cool, dry place if you won't be using the remote control for a long time. The remote control can be used up to about 23 feet from the TV. (Assuming typical TV usage, the batteries last for about one year.)

---

➤ **If the remote control doesn't work!**

**Check the following:**

**1. Is the TV power on?**

**2. Are the plus and minus ends of the batteries reversed?**

**3. Are the batteries drained?**

**4. Is there a power cut, or is the power cord unplugged?**

**5. Is there a special fluorescent light or a neon sign nearby?**

## Switching On and Off

*The mains lead is attached to the rear of your set.*

- ☞ If you purchased this set in the United Kingdom, refer to page 65 for further instructions on plug wiring.

- 1 Plug the mains lead into an appropriate socket.

**Result:** The standby indicator lights up on the front panel.

- The main voltage is indicated on the rear of your set and the frequency is 50 or 60Hz.

- 2 Press the **POWER** ⏻ button on the front of the panel.

**Result:** The programme that you were watching last is reselected automatically.

- 3 Press the numeric button (0~9) or channel up/down (⬆/⬇) button on the remote control or **C/P** ⬆ ⬇ button on the right side of the panel.

- When you switch the set on for the very first time, you will be asked to choose language in which the menus are to be displayed (see page 14).

- 4 To switch your set off, press the **POWER** ⏻ button again.



## Placing Your Television in Standby Mode

*Your set can be placed in standby mode in order to reduce the power consumption. The standby mode can be useful when you wish to interrupt viewing temporarily (during a meal, for example).*

- 1 Press the **POWER** ⏻ button on the remote control.

**Result:** The screen is turned off and a red standby indicator appears on the front of your set.

- 2 To switch your set back on, simply press the **POWER** ⏻, numeric buttons (0~9) or channel up/down (⬆/⬇) button again.

- Do not leave your set in standby mode for long periods of time (when you are away on holiday, for example). It is best to unplug the set from the mains and aerial.



## Becoming Familiar with the Remote Control

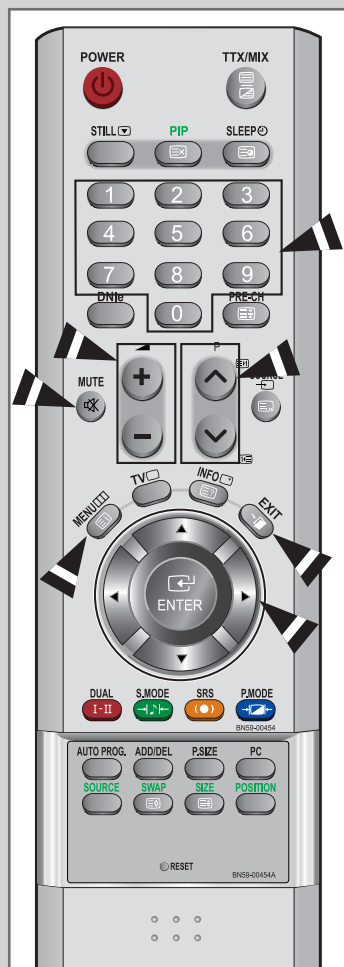

The remote control is used mainly to:

- ◆ Change channels and adjust the volume.
- ◆ Set up your set using the on-screen menu system.

The following table presents the most frequently used buttons and their functions.

Button	Viewing Function	Menu Function
	Used to display the next stored channel.	-
	Used to display the previous stored channel.	-
	Used to display the corresponding channels. ➤ For double digit channels, the second digit must be pushed immediately after the first. Failure to do this will result in a single digit channel being displayed.	-
	Used to increase the volume.	-
	Used to decrease the volume.	-
<b>MUTE</b> 	Used to switch the sound off temporarily. ➤ To turn the sound back on, press this button again, or press the  button.	-
<b>MENU</b> 	Used to display the on-screen menu system.	Used to return to the previous menu or normal viewing.
<b>EXIT</b> 	Used to exit the on-screen menu system.	-
	<ul style="list-style-type: none"> <li>▲ ▼ Used to move among the menu items.</li> <li>▶ Used to select a menu item or increase the value of the selected item.</li> <li>◀ Used to return to the previous menu item or decrease the value of the selected item.</li> </ul>	-
<b>ENTER</b> 	-	Used to confirm your choice.

# Plug and Play

When the set is initially powered ON, several basic customer settings proceed automatically and subsequently. The following settings are available.

- 1 If the set is in standby mode, press the **POWER**  button on the remote control.

**Result:** The message **Start Plug & Play.** is displayed. It appears for a little while, and then the **Language** menu is automatically displayed.

- 2 Select the appropriate language by pressing the **▲** or **▼** button.

➤ The available languages are listed.  
You can choose one of 21 languages.

- 3 Press the **ENTER**  button to confirm your choice.

**Result:** The message **Check antenna input.** is displayed with the **OK** selected.

- 4 Press the **ENTER**  button.

**Result:** The following areas are available:  
**Belgium - France - Germany - Italy -  
Netherlands - Spain - Sweden - Switzerland -  
United Kingdom - Eastern Europe- Others**

- 5 Select your **Country** by pressing the **▲** or **▼** button.  
Press the **ENTER**  button.

**Result:** The **Auto Store** menu is displayed with the **Start** selected.

- 6 Press the **ENTER**  button.

**Result:** The channel search will start and end automatically.

- 7 Press the **ENTER**  button.  
Select the hour or minute by pressing the **◀** or **▶** button.  
Set the hour or minute by pressing the **▲** or **▼** button.  
(Refer to "Setting and Displaying the Current Time" on page 40)

- 8 Press the **ENTER**  button to confirm your setting.

**Result:** The message **Enjoy your watching.** is displayed, and then the channel which has been stored will be activated.

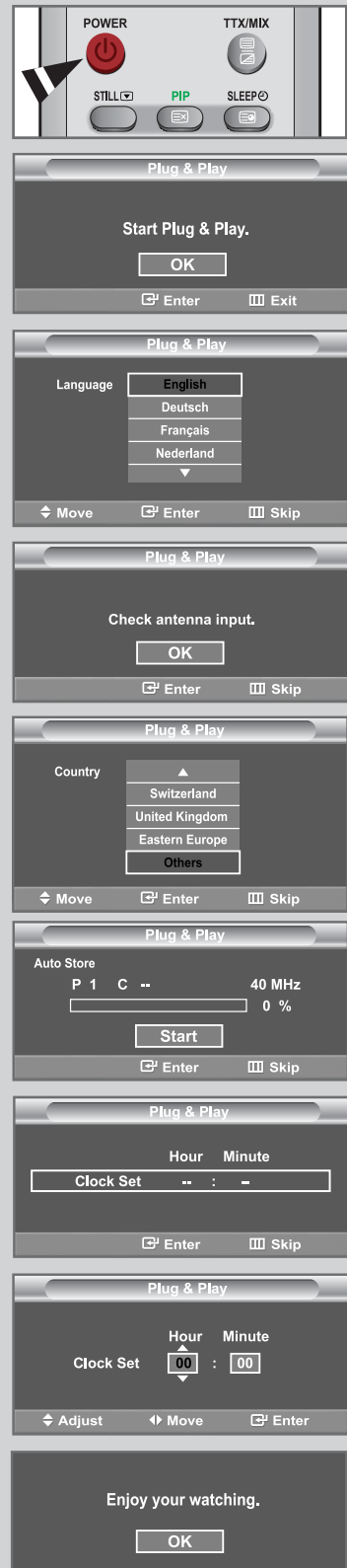

## Plug and Play



*If you want to reset this feature...*

- 1 Press the **MENU** button.  
Result: The main menu is displayed.
- 2 Press the **▲** or **▼** button to select **Setup**.  
Press the **ENTER** button.  
Result: The options available in the **Setup** group are displayed.
- 3 The **Plug & Play** is selected.
- 4 Press the **ENTER** button.  
Result: The message **Start Plug & Play.** is displayed.
- 5 For further details on how to set, refer to the previous page.

## Choosing Your Language



*When you start using your set for the first time, you must select the language which will be used for displaying menus and indications.*

- 1 Press the **MENU** button.  
Result: The main menu is displayed.
- 2 Press the **▲** or **▼** button to select **Setup**.  
Result: The options available in the **Setup** group are displayed.
- 3 Press the **ENTER** button.
- 4 Press the **▲** or **▼** button to select **Language**.  
Press the **ENTER** button.  
Result: The available languages are listed.
- 5 Select a particular language by pressing the **▲** or **▼** button repeatedly.  
Press the **ENTER** button.  
➤ You can choose one of 21 languages.
- 6 When you are satisfied with your choice, press the **EXIT** button to return to normal viewing.



# Storing Channels Automatically

You can scan for the frequency ranges available to you (and availability depends on your country). Automatically allocated programme numbers may not correspond to actual or desired programme numbers. However, you can sort numbers manually and clear any channels you do not wish to watch.

- 1 Press the **MENU** button.

**Result:** The main menu is displayed.

- 2 Press the **▲** or **▼** button to select **Channel**.

**Result:** The options available in the **Channel** group are displayed.

- 3 Press the **ENTER** button.

**Result:** The **Country** is selected.

- 4 Press the **ENTER** button again. Select your **Country** by pressing the **▲** or **▼** button repeatedly.

**Result:** The following countries are available:  
**Belgium - France - Germany - Italy - Netherlands - Spain - Sweden - Switzerland - United Kingdom - Eastern Europe - Others**

- 5 Press the **ENTER** button.

- 6 Press the **▲** or **▼** button to select **Auto Store**. Press the **ENTER** button.

**Result:** The **Auto Store** menu is displayed with the **Start** selected.

- 7 Press the **ENTER** button to search the channels. The sub menu is changed from **Start** to **Stop** with channel search started.

**Result:** The search will end automatically. Channels are sorted and stored in an order which reflects their position in the frequency range (with lowest first and highest last). The programme originally selected is then displayed.

➤ To return to the previous menu, press the **MENU** button.

➤ To stop the search before it has finished, press the **ENTER** button with **Stop** selected.

- 8 When the channels have been stored, you can:
  - ◆ Sort them in the order required (refer to page 19)
  - ◆ Assign names to the stored channels (refer to page 20)
  - ◆ Add or delete the channels (refer to page 18)
  - ◆ Fine tune channel reception if necessary (refer to page 21)

Channels can be stored automatically by simply pressing the **AUTO PROG.** button on the remote control.

- 1 Press the **AUTO PROG.** button while viewing a TV programme.

**Result:** The **Auto Store** menu is displayed with the **Start** selected.

- 2 Press the **ENTER** button.

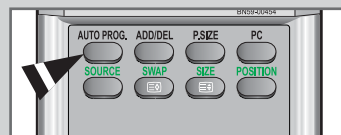
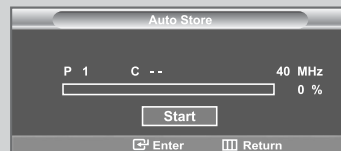

## Storing Channels Manually

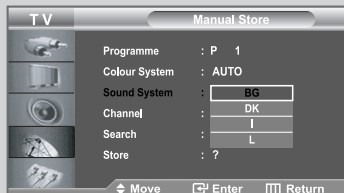
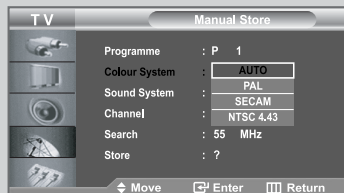
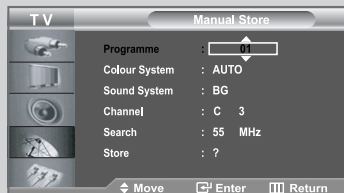
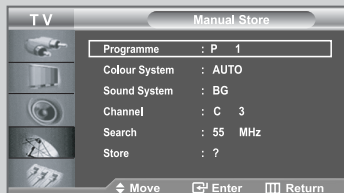

You can store up to 100 channels, including those received via cable networks. When storing channels manually, you can choose:

- ◆ Whether or not to store each of the channels found.
- ◆ The programme number of each stored channel which you wish to identify.

- Press the **MENU** button.  
Result: The main menu is displayed.
- Press the **▲** or **▼** button to select **Channel**.  
Result: The options available in the **Channel** group are displayed.
- Press the **ENTER** button.
- Press the **▲** or **▼** button to select **Manual Store**. Press the **ENTER** button.  
Result: The options available in the **Manual Store** menu are displayed with **Programme** selected.
- Press the **ENTER** button again.  
To assign a programme number to a channel, find the correct number by pressing the **▲** or **▼** button and then press the **ENTER** button.  
➤ You can also set a programme number by pressing number buttons on the remote control.
- Press the **▲** or **▼** button to select **Colour System** and then press the **ENTER** button.  
Select the colour standard required by pressing the **▲** or **▼** button repeatedly and then press the **ENTER** button.  
Result: The colour standards are displayed in the following order:  
**AUTO - PAL - SECAM - NTSC 4.43**
- Press the **▲** or **▼** button to select **Sound System** and then press the **ENTER** button.  
Select the sound standard required by pressing the **▲** or **▼** button repeatedly and then press the **ENTER** button.  
Result: The sound standards are displayed in the following order:  
**BG - DK - I - L**

## Storing Channels Manually

- 8 If you know the number of the channel to be stored,
- ◆ Press the ▲ or ▼ button to select **Channel** and then press the **ENTER** button.
  - ◆ Select **C** (Air channel) or **S** (Cable channel) by pressing the ▲ or ▼ button.
  - ◆ Press the ► button to select channel.
  - ◆ Select the required number by pressing the ▲ or ▼ button and then press the **ENTER** button.
  - If there is an abnormal sound or no sound, re-select the sound system required.
  - You can also set a channel by pressing number buttons on the remote control.

- 9 If you do not know the channel numbers, press the ▲ or ▼ button to select **Search** and then press the **ENTER** button. **Search** by pressing the ▲ or ▼ button and then press the **ENTER** button.

Result: The tuner scans the frequency range until the first channel or the channel that you selected is received on your screen.

- 10 Press the ▲ or ▼ button to select **Store**. Select **OK** by pressing the **ENTER** button.
- Result: The channel and associated programme number are stored.

- 11 Repeat steps 8 to 10 for each channel to be stored.

### Channel mode

- ◆ **P** (Programme mode): When tuning is completed, the broadcasting stations in your area will have been assigned to position numbers from P00 to P99. You can select a channel by entering the position number in this mode.
- ◆ **C** (Real channel mode): You can select a channel by entering the assigned number to each broadcast station in this mode.
- ◆ **S** (Cable channel mode): You can select a channel by entering the assigned number to each cable channel in this mode.

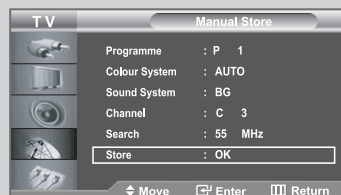
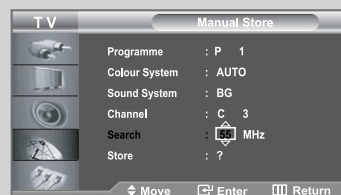
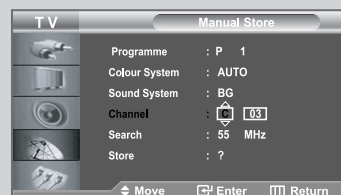

## Editing the Channels

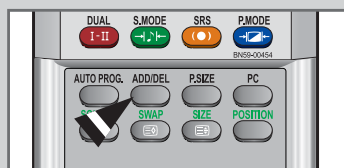
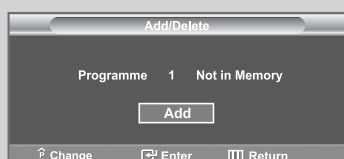
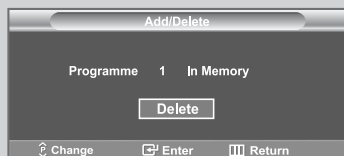

*You can exclude the channels you chose from the channels you scanned. When you scan through the stored channels, those you have chosen to skip are not displayed.*

*All channels that you do not specifically choose to skip are displayed during scanning.*

- 1 Press the **MENU** button.  
Result: The main menu is displayed.
- 2 Press the **▲** or **▼** button to select **Channel**.  
Press the **ENTER** button.  
Result: The options available in the **Channel** group are displayed.
- 3 Press the **▲** or **▼** button to select **Add/Delete**.  
Press the **ENTER** button.  
Result: The state of the current channel is displayed.
- 4 Press the **↻** button to select channel that you wish to add or delete.  
Result: If the channel that you wish to edit is not in memory, the **Add** is selected and displayed.  
Otherwise, if the channel that you wish to edit is in memory, the **Delete** is selected and displayed.
- 5 Press the **ENTER** button to add or delete channel.
- 6 Press the **MENU** button to return to the previous menu or press the **EXIT** button to return to normal viewing.
- 7 Repeat steps 4 and 5 for each channel to be added or deleted.

➤ You can also add or delete channel by simply pressing the **ADD/DEL** button on remote control.

# Sorting the Stored Channels

You can exchange the numbers of two channels, in order to:

- ◆ *Modify the numeric order in which the channels have been automatically stored.*
- ◆ *Give easily remembered numbers to the channels that you watch most often.*

1 Press the **MENU**  button.

Result: The main menu is displayed.

2 Press the **▲** or **▼** button to select **Channel**.  
Press the **ENTER**  button.

Result: The options available in the **Channel** group are displayed.

3 Press the **▲** or **▼** button to select **Sort**.  
Press the **ENTER**  button.

Result: The **Prog.**, **Ch.** and **Name** are displayed.

4 Select the channel number that you wish to change by pressing the **▲** or **▼** button repeatedly.  
Press the **ENTER**  button.

Result: The selected channel number and name are moved to right side.

5 Press the **▲** or **▼** button to move to the position in which you would like to change and then press the **ENTER**  button.

Result: The selected channel is exchanged with the one previously stored to the chosen number.

6 Repeat steps 4 to 5 for another channel to be sorted.

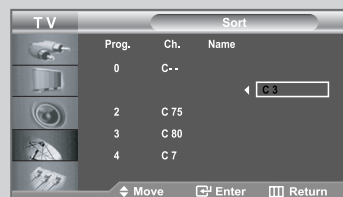
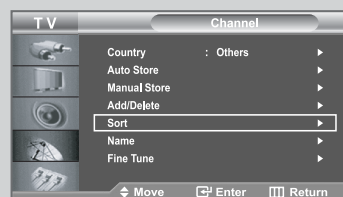

# Assigning Channels Names

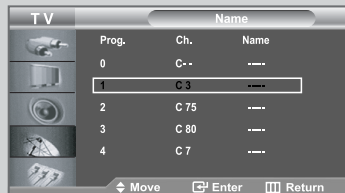

*Channel names will be assigned automatically when channel information is broadcast. These names can be changed, allowing you to assign new names.*

- 1 Press the **MENU** button.

Result: The main menu is displayed.

- 2 Press the **▲** or **▼** button to select **Channel**. Press the **ENTER** button.

Result: The options available in the **Channel** group are displayed.

- 3 Press the **▲** or **▼** button to select **Name**. Press the **ENTER** button.

Result: The current **Prog.**, **Ch.** and **Name** are displayed.

- 4 If necessary, select the channel to be assigned to a new name by pressing the **▲** or **▼** button. Press the **ENTER** button.

Result: The selection bar is displayed around the name box.

5	To...	Then...
	Select a letter, number or symbol	Press the <b>▲</b> or <b>▼</b> button
	Move on the next letter	Press the <b>▶</b> button
	Move back the previous letter	Press the <b>◀</b> button
	Confirm the name	Press the <b>ENTER</b> button

- The characters available are :
- ◆ Letters of the alphabet (A~Z)
  - ◆ Numbers (0~9)
  - ◆ Special characters ( -, space)

- 6 Repeat steps 4 to 5 for each channel to be assigned to a new name.

- 7 When you are satisfied with the setting, press the **MENU** button to return to the previous menu or press the **EXIT** button to return to normal viewing.

# Fine Tuning Channel Reception

*If the reception is clear, you do not have to fine-tune the channel, as this is done automatically during the search and store operation. If however, the signal is weak or distorted, you may have to fine-tune the channel manually.*

➤ Select the channel that you want to fine tune.

- 1 Press the **MENU**  button.

Result: The main menu is displayed.

- 2 Press the **▲** or **▼** button to select **Channel**.  
Press the **ENTER**  button.

Result: The options available in the **Channel** group are displayed.

- 3 Press the **▲** or **▼** button to select **Fine Tune**.  
Press the **ENTER**  button.

Result: The horizontal bar is displayed.

- 4 Press the **◀** or **▶** button to reach the required setting.  
Press the **ENTER**  button.

Result: An asterisk “\*” appears on the right-hand side of the channel number. The channel number becomes red.

➤ To reset the fine-tuning, select **Reset** by pressing the **▲** or **▼** button and then press the **ENTER**  button.

- 5 When you are satisfied with the setting, press the **MENU**  button to return to the previous menu or press the **EXIT** button to return to normal viewing.

➤ Fine tuned channels that have been saved are marked with an asterisk “\*” on the right-hand side of the channel number in the channel banner. And the channel number becomes red.

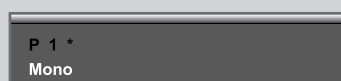
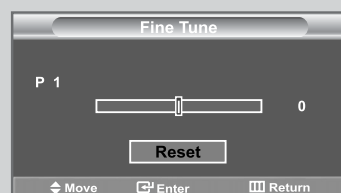
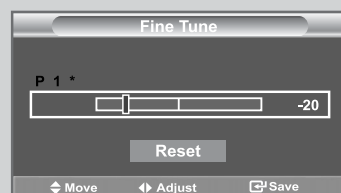
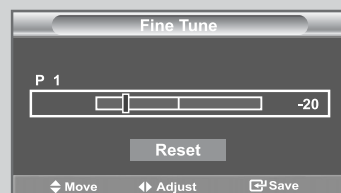
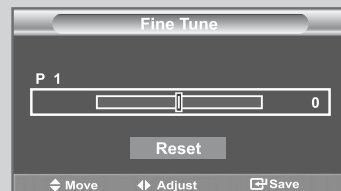
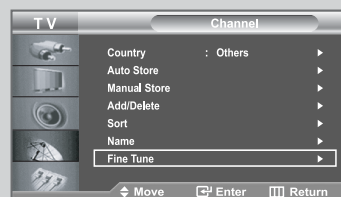

# Changing the Picture Standard

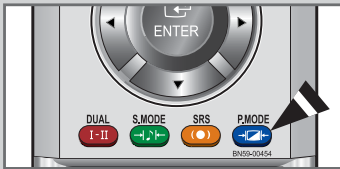
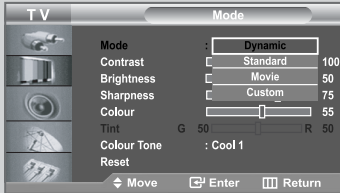
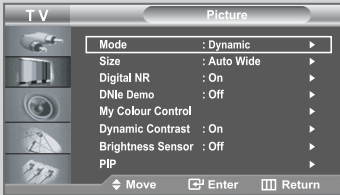

You can select the type of picture which best corresponds to your viewing requirements.

1 Press the **MENU** button.

Result: The main menu is displayed.

2 Press the **▲** or **▼** button to select **Picture**.

Result: The options available in the **Picture** group are displayed.

3 Press the **ENTER** button.

4 Press the **ENTER** button again.

Result: The options available in the **Mode** group are displayed.

5 Press the **ENTER** button.

Result: The **Mode** is selected.

6 Select the required picture effect by pressing the **▲** or **▼** button repeatedly.

Result: The following picture effects are available:  
**Dynamic - Standard - Movie - Custom**

7 When you are satisfied with the setting, press the **MENU** button to return to the previous menu or press the **EXIT** button to return to normal viewing.

➤ You can also display by simply pressing the **P.MODE** (Picture Mode) button.



# Adjusting the Custom Picture

Your set has several settings which allow you to control picture quality.

- 1 Press the **MENU** button.  
Result: The main menu is displayed.
- 2 Press the **▲** or **▼** button to select **Picture**.  
Result: The options available in the **Picture** group are displayed.
- 3 Press the **ENTER** button.  
Result: The options available in the **Mode** group are displayed.
- 4 Press the **ENTER** button again.  
Result: The options available in the **Mode** group are displayed.
- 5 Select the option (**Contrast**, **Brightness**, **Sharpness**, **Colour**, **Tint**) to be adjusted by pressing the **▲** or **▼** button. Press the **ENTER** button.  
Result: The horizontal bar is displayed.
- 6 Press the **◀** or **▶** button to reach the required setting. Press the **ENTER** button.
- 7 When you are satisfied with the setting, press the **MENU** button to return to the previous menu or press the **EXIT** button to return to normal viewing.

- ◆ Each adjusted setting will be stored separately according to its input mode.
- ◆ The Tint is "inactivated" as following cases.
  - Analog mode (RF, Scart, Video, S-Video)  
In case of an input signal setting to PAL-50, PAL-CN, and SECAM.
  - Component, DVI, and HDMI mode  
In case of an input signal setting to 60HZ; 480i, 480p, 720p @60Hz, 1080i @60Hz.

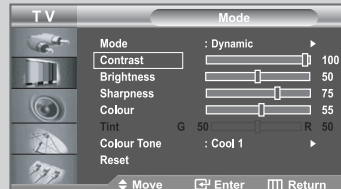
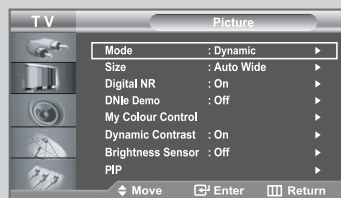

## Changing the Colour Tone

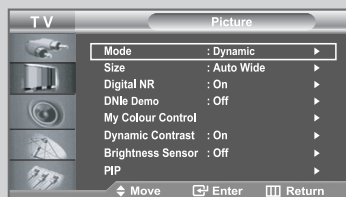

*You can select the most comfortable colour tone to your eye.*

- 1 Press the **MENU** button.  
Result: The main menu is displayed.
- 2 Press the **▲** or **▼** button to select **Picture**.  
Result: The options available in the **Picture** group are displayed.
- 3 Press the **ENTER** button.
- 4 Press the **ENTER** button again.  
Result: The options available in the **Mode** group are displayed.
- 5 Press the **▲** or **▼** button to select **Colour Tone** and press the **ENTER** button. Select the required option by pressing the **▲** or **▼** button repeatedly. Press the **ENTER** button.  
Result: The following options are available:  
**Cool2 - Cool1 - Normal - Warm1 - Warm2**
- 6 When you are satisfied with your choice, press the **EXIT** button to return to normal viewing.

## Resetting the Picture Settings to the Factory Defaults

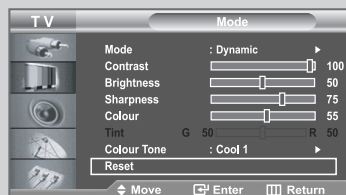
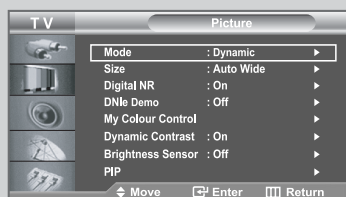

*You can return to the factory defaults picture settings.*

- 1 Press the **MENU** button.  
Result: The main menu is displayed.
- 2 Press the **▲** or **▼** button to select **Picture**.  
Result: The options available in the **Picture** group are displayed.
- 3 Press the **ENTER** button.
- 4 Press the **ENTER** button again.  
Result: The options available in the **Mode** group are displayed.
- 5 Press the **▲** or **▼** buttons to select **Reset**, then press the **ENTER** button.
- 6 Press the **EXIT** button to return to normal viewing.

## Changing the Picture Size

You can select the picture size which best corresponds to your viewing requirements.

1 Press the **MENU**  button.

**Result:** The main menu is displayed.

2 Press the **▲** or **▼** button to select **Picture**.

**Result:** The options available in the **Picture** group are displayed.

3 Press the **ENTER**  button.



4 Press the **▲** or **▼** button to select **Size** and press the **ENTER**  button.

5 Select the required option by pressing the **▲** or **▼** button repeatedly.

Press the **ENTER**  button.

**Result:** The following options are available:

**Auto Wide – Wide – Panorama – Zoom – 4:3**

➤ **Zoom** : Magnifies the 16:9 wide picture (in the vertical direction) to fit the screen size. Select  by pressing the **◀** or **▶** button. Use the **▲** or **▼** button to move the picture up and down. After selecting , use the **▲** or **▼** button to magnify or reduce the picture size in the vertical direction.

- ◆ You can select these options by simply pressing the **P.SIZE** (Picture Size) button on the remote control.
- ◆ In PC Mode, only Wide and 4:3 mode can be adjusted.
- ◆ If you press **P.SIZE** (Picture Size) button when PIP is set to on, PIP function will be cancelled and the picture size will be changed.

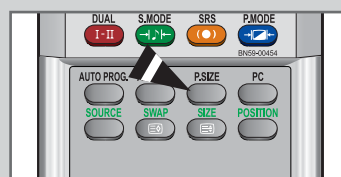
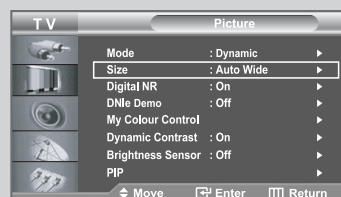

## Freezing the Current Picture

Press the **STILL** button to freeze a moving picture into a still one. Press again to cancel.



## Using the Digital NR (Digital Noise Reduction) Feature

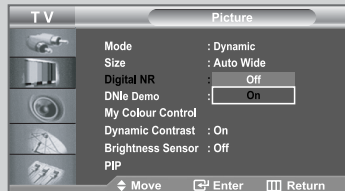
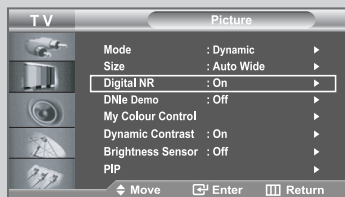

*If the signal received by your television is weak, you can activate this feature to help reduce any static and ghosting that may appear on the screen.*

- 1 Press the **MENU** button.  
Result: The main menu is displayed.
- 2 Press the **▲** or **▼** button to select **Picture**.  
Result: The options available in the **Picture** group are displayed.
- 3 Press the **ENTER** button.
- 4 Press the **▲** or **▼** button to select **Digital NR**.  
Press the **ENTER** button.
- 5 Press the **▲** or **▼** button to select **On**.  
Press the **ENTER** button.
- 6 Press the **EXIT** button to return to normal viewing.

# DNle (Digital Natural Image engine)

*Samsung's new technology brings you more detailed images with contrast and white enhancement. A new image compensation algorithm gives viewers brighter and clearer images.*

*DNle technology will match every signal to your eyes.*

*You can see how DNle improves the picture by setting DNle Demo mode to On.*

1 Press the **MENU**  button.

Result: The main menu is displayed.

2 Press the **▲** or **▼** button to select **Picture**.

Result: The options available in the **Picture** group are displayed.

3 Press the **ENTER**  button.

4 Press the **▲** or **▼** button to select **DNle Demo** and then press the **ENTER**  button.

Press the **▲** or **▼** button to select **On**.

Press the **ENTER**  button.

➤ **DNle Demo: Off**  
DNle Demo mode is deactivated.

**DNle Demo: On**  
The right-hand side of the screen shows improved DNle image. The left-hand side of the screen shows the original image.

➤ You can also select these options by simply pressing the **DNle** button.

5 When you are satisfied with your choice, press the **EXIT** button to return to normal viewing.

- This function doesn't work when source is in PC mode.
- The **DNle Demo** is designed to show the difference between the regular and DNle pictures.
- By default, the product displays the picture with DNle applied.

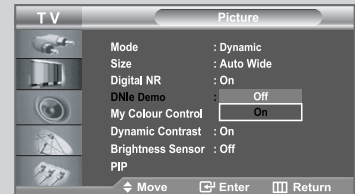
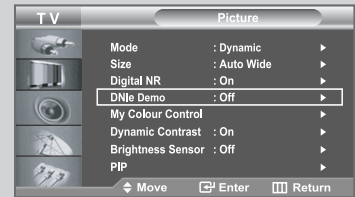

# My Colour Control

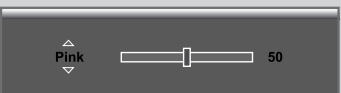
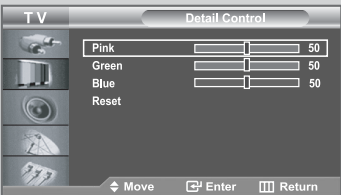
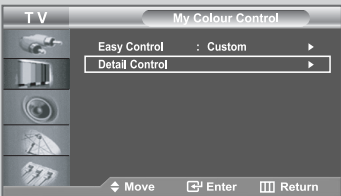
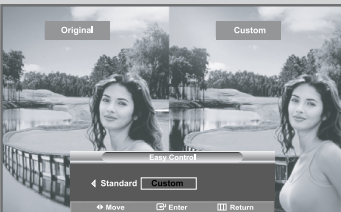
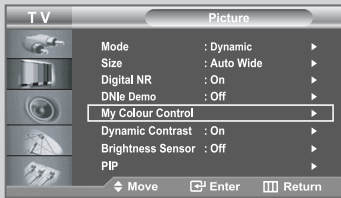





*My Colour Control is to adjust the most preferred colours such as Blue, Green, Pink without interfering with other colours in order for each consumer to enjoy screen colour of its choice.*

- 1 Press the **MENU** button.  
Result: The main menu is displayed.
- 2 Press the **▲** or **▼** button to select **Picture**.  
Result: The options available in the **Picture** group are displayed.
- 3 Press the **ENTER** button.
- 4 Press the **▲** or **▼** button to select **My Colour Control** and then press the **ENTER** button.  
Result: The options available in the **My Colour Control** menu are displayed.
- 5 Press the **▲** or **▼** button to select **Easy Control** and press the **ENTER** button. Select a source of the sub picture by pressing the **◀** or **▶** button and press the **ENTER** button.  
Result: The sources are displayed in the following order:  
**Blue - Green - Pink - Standard - Custom**
- 6 Press the **▲** or **▼** button to select **Detail Control** and press the **ENTER** button. Select a source of the sub picture by pressing the **▲** or **▼** button and press the **ENTER** button.  
Result: The sources are displayed in the following order:  
**Pink - Green - Blue- Reset**
- 7 Press the **◀** or **▶** button to reach the required setting. Press the **ENTER** button.
- 8 When you are satisfied with the setting, press the **MENU** button to return to the previous menu or press the **EXIT** button to return to normal viewing.

- This function captures the current screen in a still image to adjust the colour.
- This function doesn't work when source is in PC mode.
- To return to the factory default settings for My Colour Control colours, select **Reset** by pressing the **▲** or **▼** button and then press the **ENTER** button.

# Dynamic Contrast

*Dynamic Contrast is to automatically detect distribution of inputted visual signal and adjust to create optimum contrast.*

- 1 Press the **MENU**  button.  
Result: The main menu is displayed.
- 2 Press the **▲** or **▼** button to select **Picture**.  
Result: The options available in the **Picture** group are displayed.
- 3 Press the **ENTER**  button.
- 4 Press the **▲** or **▼** button to select **Dynamic Contrast**.  
Press the **ENTER**  button.  
Result: The **Dynamic Contrast** menu is displayed.
- 5 Select **On** by pressing the **▲** or **▼** button.  
Press the **ENTER**  button.
- 6 When it has finished, press the **EXIT** button to return to normal viewing.

➤ This function doesn't work when source is in PC mode or PIP is set to on.

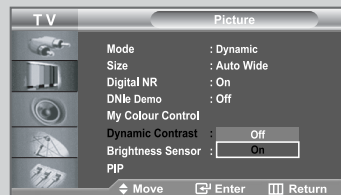
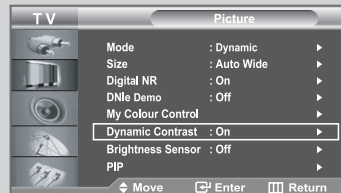
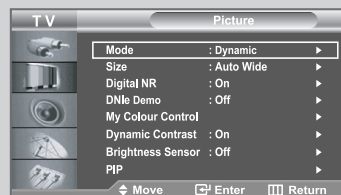

# Brightness Sensor

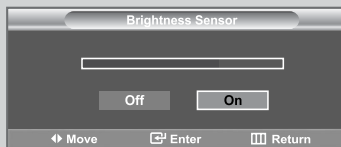
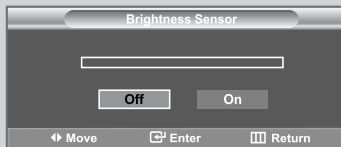
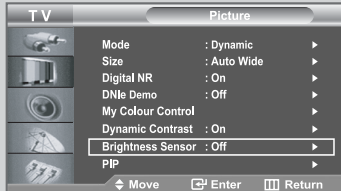
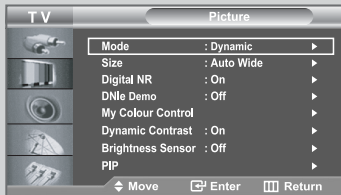

*Brightness Sensor is to adjust brightness of screen either automatically or manually by detecting brightness of surrounding environment using light detecting sensor.*

- 1 Press the **MENU** button.  
Result: The main menu is displayed.
- 2 Press the **▲** or **▼** button to select **Picture**.  
Result: The options available in the **Picture** group are displayed.
- 3 Press the **ENTER** button.  
Result: The **Brightness Sensor** menu is displayed.
- 4 Press the **▲** or **▼** button to select **Brightness Sensor**. Press the **ENTER** button.  
Result: The **Brightness Sensor** menu is displayed.
- 5 Select **On** by pressing the **◀** or **▶** button. Press the **ENTER** button.  
Result: Brightness on the screen is adjusted automatically according to brightness of surrounding environment.
- 6 When it has finished, press the **ENTER** button to return to the previous menu or press the **EXIT** button to return to normal viewing.

➤ This function doesn't work when source is in PC mode.



# Viewing the Picture In Picture (PIP)

You can display a sub picture within the main picture of set programme or video input. In this way, you can watch the picture of set programme or video input from any connected equipment whiling watching the main picture.

- 1 Press the **MENU**  button.  
Result: The main menu is displayed.

---

- 2 Press the **▲** or **▼** button to select **Picture**.  
Result: The options available in the **Picture** group are displayed.



---

- 3 Press the **ENTER**  button.



---

- 4 Press the **▲** or **▼** button to select **PIP** and then press the **ENTER**  button.  
Result: The options available in the **PIP** menu are displayed.

---

- 5 Press the **ENTER**  button again. Select **On** by pressing the **▲** or **▼** button and then press the **ENTER**  button.



---

- 6 Press the **▲** or **▼** button to select **Source** and press the **ENTER**  button. Select a source of the sub picture by pressing the **▲** or **▼** button and press the **ENTER**  button.  
Result: The sources are displayed in the following order:  
When the main picture is set to TV/Ext. 1/Ext. 2/AV/ S-Video/Component, only HDMI can be selected and when the main picture is set to PC/HDMI, TV/Ext.1/ Ext.2/AV/S-Video/Component can be selected.

---

- 7 Press the **▲** or **▼** button to select **Swap**. To interchange the main picture and the sub picture, select **Swap** option and press the **ENTER**  button.  
Result: The main picture and the sub picture are interchanged.  
➤ If main picture is in **PC** mode, **Swap** is not available.

---

- 8 Press the **▲** or **▼** button to select **Size** of sub picture and then press the **ENTER**  button. Select a size of the sub picture by pressing the **▲** or **▼** button and then press the **ENTER**  button.  
Result: The sizes are displayed in the following order:

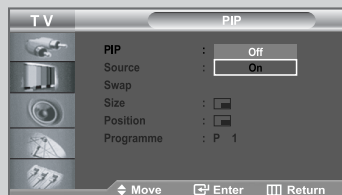
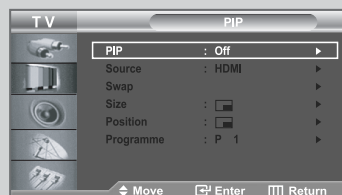
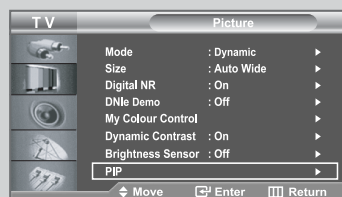

## [TV/Ext. 1/Ext. 2/AV/S-Video/Component]

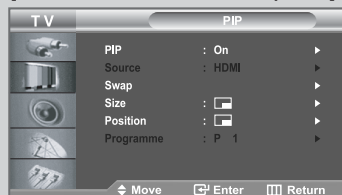

## [PC/HDMI]

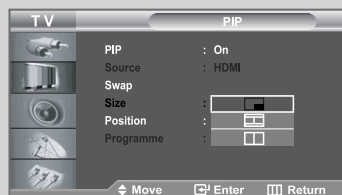
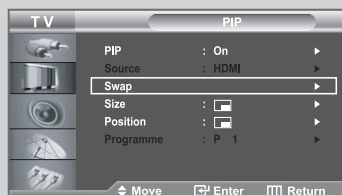
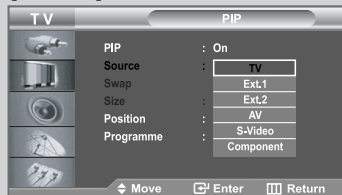

# Viewing the Picture In Picture (PIP)

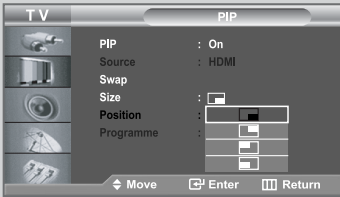

## [PC/HDMI]

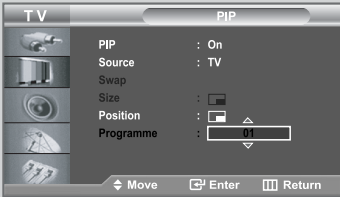

- 9 Press the **▲** or **▼** button to select **Position** and then press the **ENTER** button.  
Select the position of sub picture by pressing the **▲** or **▼** button and then press the **ENTER** button.

**Result:** You can move the sub picture.

- When the size of the sub picture is set to or , this feature does not work.

- 10 Press the **▲** or **▼** button to select **Programme** and then press the **ENTER** button. You can select the channel that you want to view through sub picture by pressing the **▲** or **▼** button. Press the **ENTER** button.

**Result:** The memorized **Programme** is displayed.

- **Main: PC/HDMI, Sub: TV**  
“Programme” is inactive and not available in TV mode. However, they become active and available in PC/HDMI mode.

- 11 To return to normal viewing, press the **EXIT** button.

### ➤ Remote-control functions while "PIP" is "On":

Features	Description
PIP	Used to operate On/Off function of PIP directly.
SOURCE	Used to select a source of the sub picture.
SWAP	Used to interchange the main picture and the sub picture. ➤ When the main picture is in the video mode and the sub picture is in the TV mode, you might not hear the sound of main picture when pressing the <b>SWAP</b> button after changing the sub picture channel. At this time, reselect the main picture channel.
POSITION	You also move the sub picture simply by pressing the <b>POSITION</b> button.
SIZE	Select a size of the sub picture by pressing the <b>SIZE</b> button.

### ➤ PIP Settings

O : PIP operates  
X : PIP doesn't operate

Main \ Sub	TV	Ext.1	Ext.2	AV	S-Video	Component	PC	HDMI
TV	X	X	X	X	X	X	X	O
Ext.1	X	X	X	X	X	X	X	O
Ext.2	X	X	X	X	X	X	X	O
AV	X	X	X	X	X	X	X	O
S-Video	X	X	X	X	X	X	X	O
Component	X	X	X	X	X	X	X	O
PC	O	O	O	O	O	O	X	X
HDMI	O	O	O	O	O	O	X	X

## Adjusting the Volume

*You can adjust the volume using your remote control.*

Press the **+** button to increase the volume.

**Result:** A horizontal bar is displayed and the volume increases until you release the button. The cursor moves to the right to indicate the volume.

Press the **-** button to decrease the volume.

**Result:** A horizontal bar is displayed and the volume decreases until you release the button. The cursor moves to the left to indicate the volume.

➤ Additional sound adjustments are available on your set.  
For further details, refer to pages **34** to **39**.



## Switching the Sound Off Temporarily



You can switch the sound off temporarily.

**Example:** You wish to answer the telephone.

- 1 Press the **MUTE** button.  
Result: The sound is switched off and “**Mute**” is displayed.
- 2 When you wish to turn the sound back on, press the **MUTE** button again or either of the volume buttons.  
Result: The sound comes back on at the same volume as before and the “**Mute**” indication disappears.

## Selecting the Sound Mode

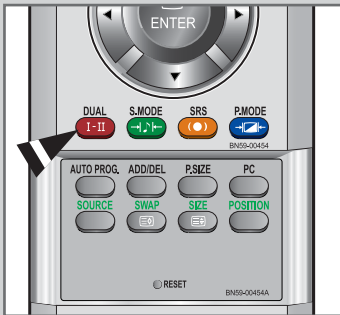

You can set the sound mode by pressing the “**DUAL**” button.

When you press it, the current sound mode is displayed on the screen.

	Audio Type	DUAL 1/2	Default
<b>FM Stereo</b>	Mono	<b>MONO</b>	Automatic change
	Stereo	<b>STEREO ↔ MONO</b>	
	Dual	<b>DUAL 1 ↔ DUAL 2</b>	DUAL 1
	Mono	<b>MONO</b>	Automatic change
Stereo	<b>MONO ↔ STEREO</b>		
<b>NICAM Stereo</b>	Dual		DUAL 1

- ◆ If the receiving conditions deteriorate, listening will be easier if the mode is set to **Mono**.
- ◆ If the stereo signal is weak and automatic switching occurs, switch to **Mono**.

## Changing the Sound Standard

You can select the type of the special sound effect to be used when watching a given broadcast.

- 1 Press the **MENU** button.  
Result: The main menu is displayed.
- 2 Press the **▲** or **▼** button to select **Sound**.  
Result: The options available in the **Sound** group are displayed.
- 3 Press the **ENTER** button.
- 4 Press the **ENTER** button again.  
Result: The **Mode** is selected.
- 5 Select the required sound effect by pressing the **▲** or **▼** button repeatedly and then press the **ENTER** button.  
Result: The following sound effects are available:  
**Standard - Music - Movie - Speech - Custom**
- 6 When you are satisfied with the setting, press the **MENU** button to return to the previous menu or press the **EXIT** button to return to normal viewing.

➤ You can also select these options by simply pressing the **S.MODE** (Sound Mode) button on the remote control.

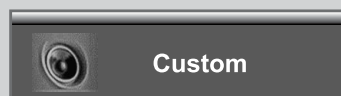
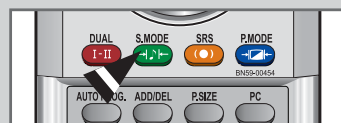
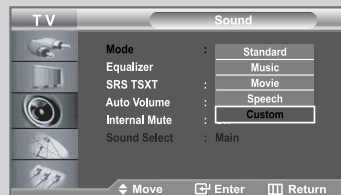
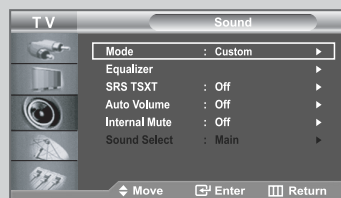

## Adjusting the Sound Settings

The sound settings can be adjusted to suit your personal preferences.

- 1 Press the **MENU** button.  
Result: The main menu is displayed.
- 2 Press the **▲** or **▼** button to select **Sound**.  
Result: The options available in the **Sound** group are displayed.
- 3 Press the **ENTER** button.
- 4 Select **Equalizer** by pressing the **▲** or **▼** button and then press the **ENTER** button.
- 5 Select the required option by pressing the **◀** or **▶** button.
- 6 Press the **▲** or **▼** button to reach the required setting.  
Press the **ENTER** button.
- 7 When you are satisfied with the setting, press the **MENU** button to return to the previous menu or press the **EXIT** button to return to normal viewing.

➤ If you make any changes to these settings, the Sound Mode is automatically switched to **Custom**.

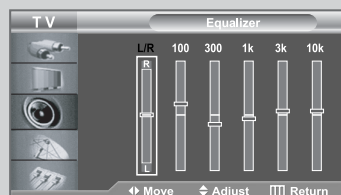
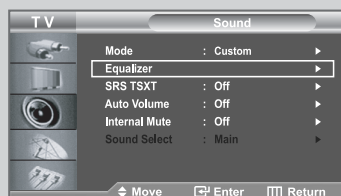

## Setting the TruSurround XT (SRS TSXT)

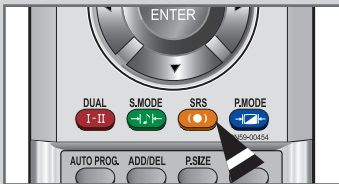
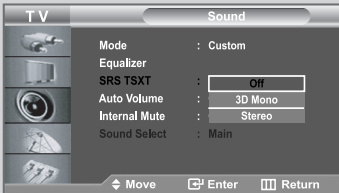
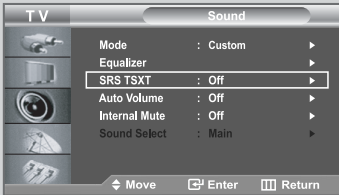

*TruSurround XT is a patented SRS technology that solves the problem of playing 5.1 multichannel content over two speakers. TruSurround delivers a compelling, virtual surround sound experience through any two-speaker playback system, including internal television speakers. It is fully compatible with all multichannel formats.*

- 1 Press the **MENU** button.

Result: The main menu is displayed.

- 2 Press the **▲** or **▼** button to select **Sound**.

Result: The options available in the **Sound** group are displayed.

- 3 Press the **ENTER** button.



- 4 Press the **▲** or **▼** button to select **SRS TSXT** and then press the **ENTER** button.

- 5 Select the required option by pressing the **▲** or **▼** button. Press the **ENTER** button.

Result: The sources are displayed in the following order:  
**Off - 3D Mono - Stereo**

- 6 Press the **EXIT** button to return to normal viewing.

➤ You can also set these options simply by pressing the **SRS** button on remote control.

**SRS**  TruSurround XT, SRS and  symbol are trademarks of SRS Labs, Inc. TruSurround XT technology is incorporated under license from SRS Labs, Inc.

## Adjusting the Volume Automatically

*Each broadcasting station has its own signal conditions, and so it is not easy for you to adjust the volume every time the channel is changed. This feature let you automatically adjust the volume of the desired channel by lowering the sound output when the modulation signal is high or by raising the sound output when the modulation signal is low.*

1 Press the **MENU**  button.

Result: The main menu is displayed.

2 Press the **▲** or **▼** button to select **Sound**.  
Press the **ENTER**  button.

Result: The options available in the **Sound** group are displayed.

3 Press the **▲** or **▼** button to select **Auto Volume**.  
Press the **ENTER**  button.

4 Press the **▲** or **▼** button to select **On**.  
Press the **ENTER**  button.

5 Press the **EXIT** button to return to normal viewing.

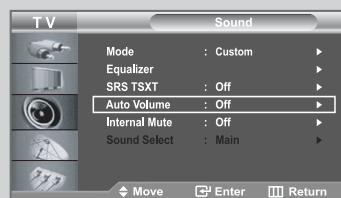

## Connecting Headphones



*You can connect a set of headphones to your set if you wish to watch a TV programme without disturbing the other people in the room.*

Plug a set of headphones into the 3.5mm mini-jack socket on the rear panel of the set.

**Result:** The sound is heard through the headphones.

- For further details on how to set your headphone preferences, refer to the section below.
  - When you insert the head set jack into the corresponding port, you can operate only **SRS TSXT**, **Internal Mute** and **Sound Select** (in PIP mode) in Sound menu.
- 
- Prolonged use of headphones at a high volume may damage your hearing.
  - You will not receive sound from the speakers when you connect headphones to the system.

## Selecting the Internal Mute

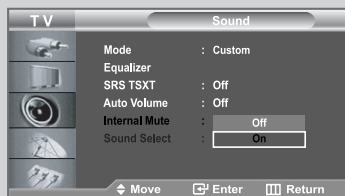
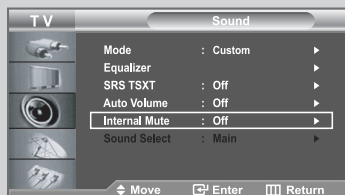

*If you want to hear the sound through separate speakers, cancel the internal amplifier.*

- 1 Press the **MENU** button.

**Result:** The main menu is displayed.

- 2 Press the **▲** or **▼** button to select **Sound**.

**Result:** The options available in the **Sound** group are displayed.

- 3 Press the **ENTER** button.

- 4 Press the **▲** or **▼** button to select **Internal Mute**. Press the **ENTER** button.

- 5 Press the **▲** or **▼** button to select **On**. Press the **ENTER** button.

- 6 Press the **EXIT** button to return to normal viewing.

- When **Internal Mute** is set to **On**, the Sound menus except for **Sound Select** (in PIP mode) cannot be adjusted.



## Listening to the Sound of the Sub Picture

*During the PIP feature is activating, you can listen to the sound of the sub picture.*

- 1 Press the **MENU** button.

Result: The main menu is displayed.

- 2 Press the **▲** or **▼** button to select **Sound**.

Result: The options available in the **Sound** group are displayed.

- 3 Press the **ENTER** button.

- 4 Press the **▲** or **▼** button to select **Sound Select** and then press the **ENTER** button.

Result: **Main** and **Sub** are displayed.

➤ You can select this option when the PIP is in "On".

- 5 Select the **Sub** by pressing the **▲** or **▼** button.  
Press the **ENTER** button.

Result: You can listen to the sound of the sub picture.

➤ To listen the sound of the current main picture, set to **Main**.

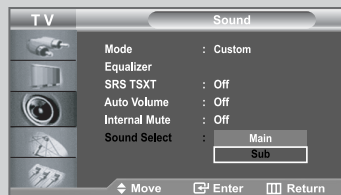
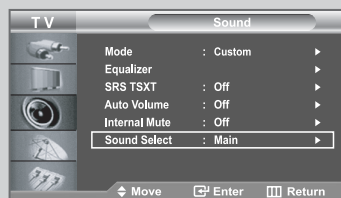

# Setting and Displaying the Current Time

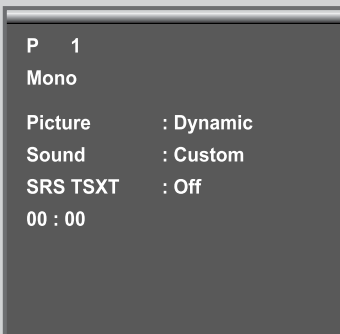
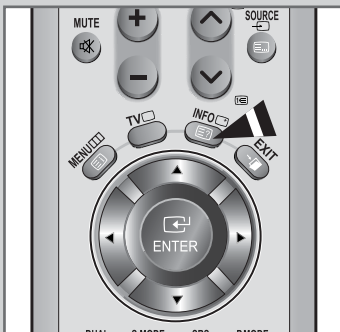
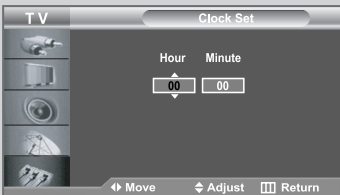
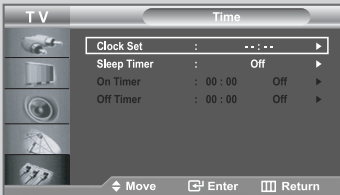

*You can set the TV's clock so that the current time is displayed when you press the **INFO** button. You must also set the time if you wish to use the automatic On/Off timers.*

➤ If you disconnect the power cord, you have to set the clock again.

- 1 Press the **MENU** button.  
Result: The main menu is displayed.

---

- 2 Press the **▲** or **▼** button to select **Setup**. Press the **ENTER** button.  
Result: The options available in the **Setup** group are displayed.

---

- 3 Press the **▲** or **▼** button to select **Time**. Press the **ENTER** button.  
Result: The **Time** menu is displayed with **Clock Set** selected.

---

- 4 Press the **ENTER** button.

---

- 5 

<b>To...</b>	<b>Press the...</b>
Move to <b>Hour</b> or <b>Minute</b>	◀ or ▶ button
Set the <b>Hour</b> or <b>Minute</b>	▲ or ▼ button

Press the **ENTER** button.

---

- 6 When you are satisfied with the setting, press the **MENU** button to return to the previous menu or press the **EXIT** button to return to normal viewing.

---

- 7 

<b>To display the...</b>	<b>Press the...</b>
Current time and selected audio/video setting status	<b>INFO</b> button

➤ You can also set hour and minute by pressing the number buttons on the remote control.

# Setting the Sleep Timer

You can select a time period of between 30 and 180 minutes after which the television automatically switches to standby mode.

- 1 Press the **MENU** button.  
Result: The main menu is displayed.
- 2 Press the **▲** or **▼** button to select **Setup**.  
Press the **ENTER** button.  
Result: The options available in the **Setup** group are displayed.
- 3 Press the **▲** or **▼** button to select **Time**.  
Press the **ENTER** button.  
Result: The **Time** menu is displayed with **Clock Set** selected.
- 4 Press the **▲** or **▼** button to select **Sleep Timer**.  
Press the **ENTER** button.
- 5 Press the **▲** or **▼** button repeatedly and cycle through the preset time intervals (Off, 30, 60, 90, 120, 150, 180).  
Press the **ENTER** button.  
Result: The TV automatically switches to standby mode when the timer reaches 0.
- 6 To cancel the sleep timer function, select **Off** by pressing the **▲** or **▼** button and then press the **ENTER** button.
- 7 Press the **EXIT** button to return to normal viewing.

You can set the sleep timer by simply pressing the **SLEEP** button on the remote control.

- 1 Press the **SLEEP** button on the remote control.  
Result: If the sleep timer is not yet set, **Off** is displayed.  
Otherwise, the remaining time before which the television switches to standby mode is displayed.
- 2 Select the preset time interval for staying on by pressing the **SLEEP** button repeatedly.

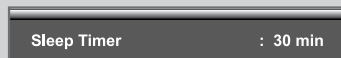
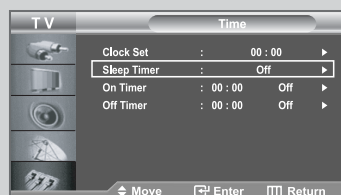
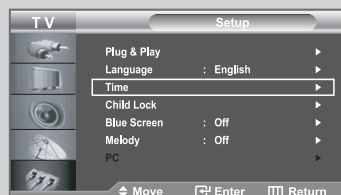

# Switching the Television On and Off Automatically

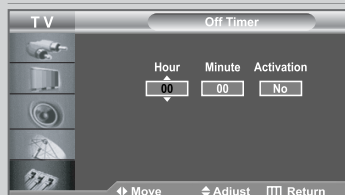
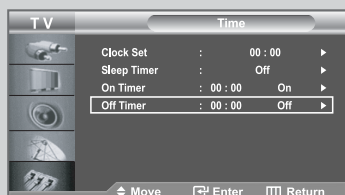
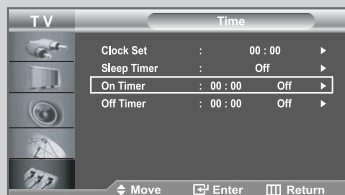

You can set the On/Off timers so that the set will:

- ◆ Switch on automatically and tune to the channel of your choice at the time you select.
- ◆ Switch off automatically at the time you select.

➤ The first step is to set the television's clock (refer to "Setting and Displaying the Current Time" on page 40).

- 1 Press the **MENU** button.  
Result: The main menu is displayed.

---

- 2 Press the **▲** or **▼** button to select **Setup**. Press the **ENTER** button.  
Result: The options available in the **Setup** group are displayed.

---

- 3 Press the **▲** or **▼** button to select **Time**. Press the **ENTER** button.  
Result: The **Time** menu is displayed with **Clock Set** selected.

---

- 4 Press the **▲** or **▼** button to select **On Timer**. Press the **ENTER** button.  
Result: The **On Timer** menu is displayed.

---

- 5 Set the time, channel and volume level at which you wish the set to be switched on.

To...	Press the...
Move to <b>Hour</b> , <b>Minute</b> , <b>Programme</b> , and <b>Volume</b>	◀ or ▶ button
Set <b>Hour</b> , <b>Minute</b> , <b>Programme</b> , and <b>Volume</b>	▲ or ▼ button
Move to <b>Activation</b>	◀ or ▶ button
Select <b>Yes</b> to enable above setting	▲ or ▼ button

Press the **ENTER** button.

---









- 6 Press the **▲** or **▼** button to select **Off Timer**. In the same way, set the time at which you wish the set to be switched off automatically.

➤ You can also set hour and minute by pressing the number buttons on the remote control.

# Activating the Child Lock

*This feature allows you to prevent unauthorized users, such as children, from watching unsuitable programmes by muting out video and audio. Child Lock cannot be released using the buttons on the lower-right panel. Only the remote control can release the Child Lock setting, so keep the remote control away from children.*

➤ *This function does not work in PC mode.*

- 1 Press the **MENU**  button.  
Result: The main menu is displayed.
- 2 Press the **▲** or **▼** button to select **Setup**.  
Press the **ENTER**  button.  
Result: The options available in the **Setup** group are displayed.
- 3 Press the **▲** or **▼** button to select **Child Lock**.  
Press the **ENTER**  button.  
Result: The options available in the **Child Lock** group are displayed.
- 4 Press the **ENTER**  button again.  
Result: The **Child Lock** is selected.
- 5 Press the **▲** or **▼** button to select **On**.  
Press the **ENTER**  button.
- 6 Press the **▲** or **▼** button to select **Programme**.  
Press the **ENTER**  button.
- 7 Press the **▲** or **▼** button to select the channels to lock.  
Press the **ENTER**  button.
- 8 Press the **▲** or **▼** button to select **Lock**.  
Press the **ENTER**  button.
- 9 Press the **▲** or **▼** button to select **Locked** to lock the channels.  
Press the **ENTER**  button.
- 10 Repeat steps 6 and 9 for each channel to be locked or unlocked.
- 11 Press the **EXIT** button to return to normal viewing.

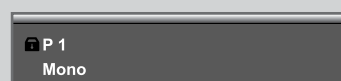

## Setting the Blue Screen Mode



*If no signal is being received or the signal is very weak, a blue screen automatically replaces the noisy picture background.*

*If you wish to continue viewing the poor picture, you must set the "Blue Screen" mode to "Off".*

- 1 Press the **MENU** button.  
Result: The main menu is displayed.
- 2 Press the **▲** or **▼** button to select **Setup**.  
Press the **ENTER** button.  
Result: The options available in the **Setup** group are displayed.
- 3 Press the **▲** or **▼** button to select **Blue Screen**.  
Press the **ENTER** button.
- 4 Press the **▲** or **▼** button to select **On**.  
Press the **ENTER** button.
- 5 Press the **EXIT** button to return to normal viewing.

## Selecting the Melody





*You can hear melody sound when the television is powered on or off.*

- 1 Press the **MENU** button.  
Result: The main menu is displayed.
- 2 Press the **▲** or **▼** button to select **Setup**.  
Press the **ENTER** button.  
Result: The options available in the **Setup** group are displayed.
- 3 Press the **▲** or **▼** button to select **Melody**.  
Press the **ENTER** button.
- 4 Press the **▲** or **▼** button to select **On**.  
Press the **ENTER** button.
- 5 Press the **EXIT** button to return to normal viewing.

# Selecting a Device from External Sources

Your set enables you to choose which audio/video signals are output to the external connector.

- 1 Press the **MENU**  button.  
Press the **ENTER**  button to select **Input**.  
**Result:** The options available in the **Input** group are displayed.

---

- 2 Press the **ENTER**  button.  
**Result:** The options available in the **Source List** menu are displayed.  
➤ When no external device is connected to your set, only **TV**, **Ext.1**, **Ext.2** are activated in the **Source List**. **AV**, **S-Video**, **Component**, **PC**, **HDMI** are activated only when they are connected to your set.

---

- 3 Select the required device by pressing the **▲** or **▼** button.  
Press the **ENTER**  button.

---

- 4 Repeat step 1.  
Press the **▲** or **▼** button to select **Edit Name**.  
Press the **ENTER**  button.  
**Result:** The options available in the **Edit Name** menu are displayed.

---

- 5 Select the device that you wish to edit by pressing the **▲** or **▼** button.  
**Result:** The following options are available:  
**Ext.1 - Ext.2 - AV - S-Video - Component - PC - HDMI**

---

- 6 Press the **ENTER**  button.

---

- 7 Select the required device by pressing the **▲** or **▼** button repeatedly.  
Press the **ENTER**  button.  
**Result:** The following options are available:  
**---- - VCR - DVD - D-VHS - Cable STB - HD STB - Satellite STB - AV Receiver - DVD Receiver - Game - Camcorder - DVD Combo - DHR - PC**

---

- 8 When you are satisfied with the setting, press the **MENU**  button to return to the previous menu or press the **EXIT** button to return to normal viewing.

➤ DHR: DVD HDD Recorder

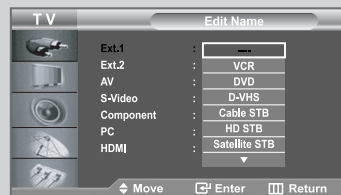
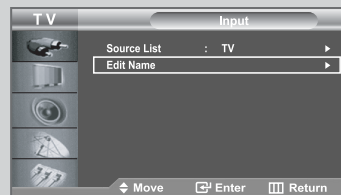

## Viewing Pictures from External Sources



*Once you have connected up your various audio and video systems, you can view the different sources by selecting the appropriate input.*

---

**1** Check that all the necessary connections have been made.

---

**2** Press the **SOURCE** button.



Result: The edited device and audio status are displayed on top-left of the set.

---

**3** Press the **SOURCE** button until the required input source is selected.

➤ If you change the external source while viewing, pictures might take a short period of time to be switched.

---

➤ **TV** mode can be selected by pressing the **TV** or  /  button on the remote control but you cannot select it by pressing the **SOURCE** button.



# Setting up Your PC Software (Based on Windows XP)

The Windows display-settings for a typical computer are shown below. But the actual screens on your PC will probably be different, depending upon your particular version of Windows and your particular video card. But even if your actual screens look different, the same, basic set-up information will apply in almost all cases. (If not, contact your computer manufacturer or Samsung Dealer.)



1 First, click on “Control Panel” on the Windows start menu.

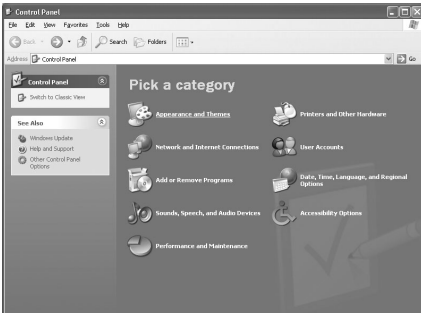

2 When the control panel window appears, click on “Appearance and Themes” and a display dialog-box will appear.

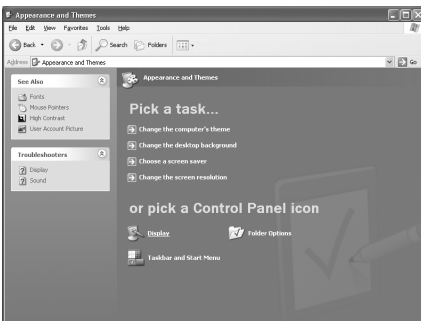

3 When the control panel window appears, click on “Display” and a display dialog-box will appear.



4 Navigate to the “Settings” tab on the display dialog-box.

The correct size setting (resolution)  
- 1360 x 768

If a vertical-frequency option exists on your display settings dialog box, the correct value is “60” or “60 Hz”. Otherwise, just click “OK” and exit the dialog box.

\*See “Display Modes” on page 63.



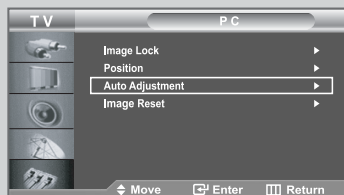
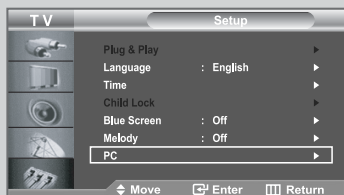
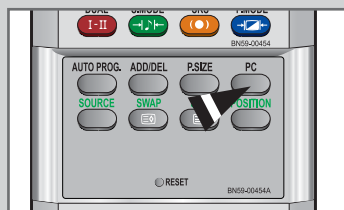

## Adjusting the PC Screen Automatically



Auto Adjustment in progress.  
Please wait.

*Auto adjustment allows the PC screen of set to self-adjust to the incoming PC video signal.  
The values of fine, coarse and position are adjusted automatically.*

➤ Press the **PC** button on the remote control to select the PC mode.

- 1 Press the **MENU**  button.  
Result: The main menu is displayed.
- 2 Press the **▲** or **▼** button to select **Setup**.  
Press the **ENTER**  button.  
Result: The options available in the **Setup** group are displayed.
- 3 Press the **▲** or **▼** button to select **PC**.  
Press the **ENTER**  button.  
Result: The options available in the **PC** menu are displayed.
- 4 Press the **▲** or **▼** button to select **Auto Adjustment**.  
Press the **ENTER**  button.  
Result: The screen quality and position are automatically adjusted.

## Coarse and Fine Tuning of the Image

*The purpose of picture quality adjustment is to remove or reduce picture noise. If the noise is not removed by Fine-tuning alone, then adjust the frequency as best as possible (coarse) and Fine-tune again. After the noise has been reduced, re-adjust the picture so that it is aligned on the center of screen.*

➤ Press the **PC** button on the remote control to select the PC mode.

1 Press the **MENU** button.

Result: The main menu is displayed.

2 Press the **▲** or **▼** button to select **Setup**.  
Press the **ENTER** button.

Result: The options available in the **Setup** group are displayed.

3 Press the **▲** or **▼** button to select **PC**.  
Press the **ENTER** button.

Result: The options available in the **PC** menu are displayed.

4 Press the **ENTER** button again.

Result: The **Image Lock** menu is selected.

5 Press the **▲** or **▼** button to select **Coarse** or **Fine**.  
Press the **ENTER** button.

Result: The horizontal bar is displayed.

6 Press the **◀** or **▶** button to adjust the screen quality.  
Press the **ENTER** button.

➤ Vertical stripes may appear or the picture may become blurry.

7 When you are satisfied with the settings, press the **MENU** button to return to the previous menu or press the **EXIT** button to return to normal viewing.

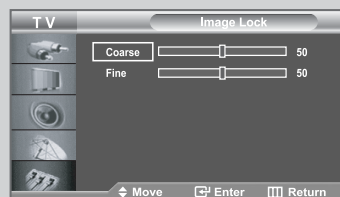
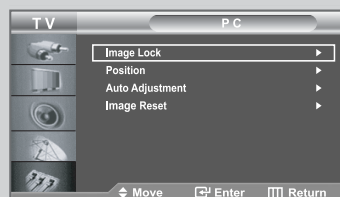
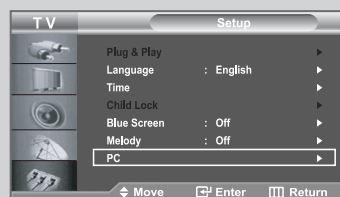
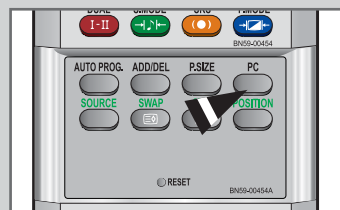

## Changing the Image Position

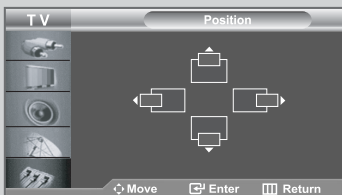
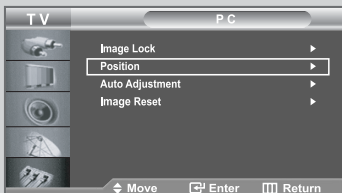
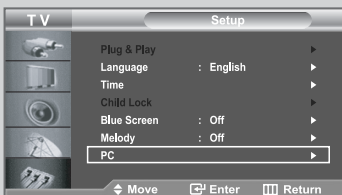
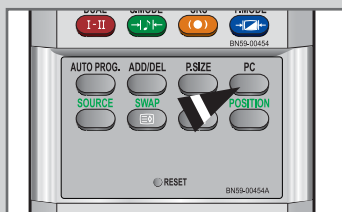

➤ Press the **PC** button on the remote control to select the PC mode.

1 Press the **MENU**  button.

Result: The main menu is displayed.

2 Press the **▲** or **▼** button to select **Setup**.  
Press the **ENTER**  button.

Result: The options available in the **Setup** group are displayed.

3 Press the **▲** or **▼** button to select **PC**.  
Press the **ENTER**  button.

Result: The options available in the **PC** menu are displayed.

4 Press the **▲** or **▼** button to select **Position**.  
Press the **ENTER**  button.

Result: You can adjust the image **Position**.

5 Press the **◀** or **▶** button to adjust horizontal position.  
Press the **▲** or **▼** button to adjust vertical position.  
Press the **ENTER**  button.

6 Press the **MENU**  button to return to the previous menu or press the **EXIT** button to return to normal viewing.

# Initializing the Image Settings

You can replace all image settings with the factory default values.

➤ Press the **PC** button on the remote control to select the PC mode.

1 Press the **MENU** button.

Result: The main menu is displayed.

2 Press the **▲** or **▼** button to select **Setup**.  
Press the **ENTER** button.

Result: The options available in the **Setup** group are displayed.

3 Press the **▲** or **▼** button to select **PC**.  
Press the **ENTER** button.

Result: The options available in the **PC** menu are displayed.

4 Press the **▲** or **▼** button to select **Image Reset**.  
Press the **ENTER** button.

Result: You can initialize all image setting to the factory default values.

5 Press the **MENU** button to return to the previous menu or press the **EXIT** button to return to normal viewing.

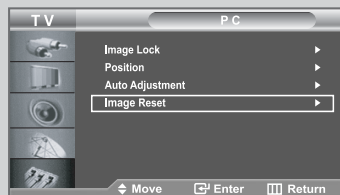
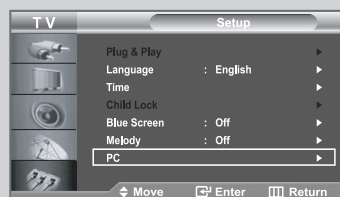
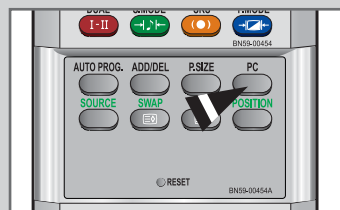
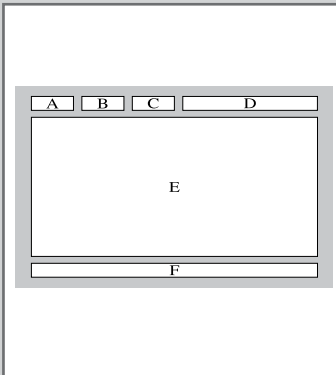

Image Reset is completed.

Return

## Teletext Decoder



Most set channels carry “teletext”, pages of written information that provide information such as:

- ◆ Television programme times.
- ◆ News bulletins and Weather forecasts.
- ◆ Sports results.
- ◆ Subtitles for the hard of hearing.

The teletext pages are organized according to six categories:

Part	Contents
A	Selected page number.
B	Broadcasting station identity.
C	Current page number or search status.
D	Date and time.
E	Text.
F	Status information.

## Displaying the Teletext Information



You can display teletext information at any time, but signal reception must be good. Otherwise:

- ◆ Information may be missing.
- ◆ Some pages may not be displayed.

To activate the teletext mode and display the contents page:

- 1 Using the (▲) or (▼) button, select the channel providing the teletext service.
- 2 Press the **TTX/MIX** (/ ) button to activate the teletext mode.  
Result: The contents page is displayed. It can be redisplayed at any time by pressing the **MENU** () button.
- 3 Press the **TTX/MIX** (/ ) button again.  
Result: The screen will split into two. This Double Teletext feature lets you view the actual broadcast and teletext information separately on the screen.
- 4 Press the **TTX/MIX** (/ ) button again.  
Result: The actual broadcast will be displayed simultaneously with the teletext page on the screen.
- 5 To return to normal viewing, press the **PIP** () button.
- 6 Press the **TV** () button again to exit from the Text display.

➤ If any broken character appears while Text is being viewed, make sure that the Text language is identical with the language in the “Setup” menu mode. If both languages are different, select the same language with the Text language on the “Setup” menu.

## Selecting a Specific Teletext Page

Press the number buttons on the remote control to enter the page number directly:

- 1 Enter the three-digit page number listed in the contents by pressing the corresponding numeric buttons.

**Result:** The current page counter is incremented and the page is then displayed.

- 2 If the selected page is linked with several secondary pages, the secondary pages are displayed in sequence. To freeze the display on a given page, press the **PRE-CH** (⏮). Press the **PRE-CH** (⏮) button again to resume.

- 3 Using the various display options:

To display...	Press the...
◆ Both teletext information and the normal broadcast	<b>TTX/MIX</b> (⏮/⏭)
◆ Hidden text (answers to quiz games, for example)	<b>INFO</b> (ℹ)
◆ The normal screen	<b>INFO</b> (ℹ) again
◆ A secondary page, by entering its 4-digit number	<b>SLEEP</b> (⏸)
◆ The next page	<b>Page Up</b> (⏮)
◆ The previous page	<b>Page Down</b> (⏭)
◆ Double-size letters in the: <ul style="list-style-type: none"> <li>• Upper half of the screen</li> <li>• Lower half of the screen</li> </ul>	<b>SIZE</b> (⏮) •Once •Twice
◆ Normal screen	•Three times



## Using Fasttext to Select a Teletext Page



*The various topics included in the teletext pages are colour-coded, and can be selected by pressing the coloured buttons on the remote control.*



- 1 Display the teletext contents page by pressing the **TTX/MIX** (☰/☷) button.
- 2 Press the coloured button corresponding to the topic that you wish to select (The available topics are listed on the status information line).  
**Result:** The page is displayed with additional colour-coded information that can be selected in the same way.
- 3 

To display the:	Press the:
Previous page	Red button.
Next page	Green button.
- 4 When you have finished, press the **PIP** (☒) button to return to the normal broadcast.



# Troubleshooting: Before Contacting Service Personnel

**Before contacting Samsung after-sales service, perform the following simple checks. If you cannot solve the problem using the instructions below, note the model and serial number of your set and contact your local dealer.**

No sound or picture	<ul style="list-style-type: none"> <li>◆ Check that the mains lead has been connected to a wall socket.</li> <li>◆ Check that you have pressed the <b>POWER</b>  buttons on the lower-right panel.</li> <li>◆ Check the picture contrast and brightness settings.</li> <li>◆ Check the volume.</li> </ul>
Normal picture but no sound	<ul style="list-style-type: none"> <li>◆ Check the volume.</li> <li>◆ Check whether the <b>MUTE</b>  button has been pressed on the remote control.</li> </ul>
No picture or black and white picture	<ul style="list-style-type: none"> <li>◆ Adjust the colour settings.</li> <li>◆ Check that the broadcast system selected is correct.</li> </ul>
Sound and picture interference	<ul style="list-style-type: none"> <li>◆ Try to identify the electrical appliance that is affecting the set and move it further away.</li> <li>◆ Plug your set into a different mains socket.</li> </ul>
Blurred or snowy picture, distorted sound	<ul style="list-style-type: none"> <li>◆ Check the direction, location and connections of your aerial. This interference is often due to the use of an indoor aerial.</li> </ul>
Remote control malfunctions	<ul style="list-style-type: none"> <li>◆ Replace the remote control batteries.</li> <li>◆ Clean the upper edge of the remote control (transmission window).</li> <li>◆ Check the battery terminals.</li> </ul>
"Check signal cable." message is displayed.	<ul style="list-style-type: none"> <li>◆ Check that the signal cable is firmly connected to the PC or video sources.</li> <li>◆ Check that the PC or video sources are turned on.</li> </ul>
On PC mode, "Not Supported Mode." message is displayed.	<ul style="list-style-type: none"> <li>◆ Check the maximum resolution and the frequency of the video adapter.</li> <li>◆ Compare these values with the data in the Display Modes.</li> </ul>
The image is too light or too dark.	<ul style="list-style-type: none"> <li>◆ Adjust the Brightness and Contrast.</li> </ul>
On PC mode, horizontal bars appear to flicker, jitter or shimmer on the image.	<ul style="list-style-type: none"> <li>◆ Adjust the Fine function.</li> </ul>
On PC mode, vertical bars appear to flicker, jitter or shimmer on the image.	<ul style="list-style-type: none"> <li>◆ Adjust the Coarse function and then adjust the Fine function.</li> </ul>
On PC mode, screen is black and power indicator light blinks every 1 second.	<ul style="list-style-type: none"> <li>◆ The TV is using its power management system.</li> <li>◆ Move the computer's mouse or press any key on the keyboard.</li> </ul>
On PC mode, image is not stable and may appear to vibrate.	<ul style="list-style-type: none"> <li>◆ Check that the display resolution and frequency from your computer or video board is an available mode for your set. On your computer check: Control Panel, Display, Settings.</li> <li>◆ If the setting is not correct, use your computer utility programme to change the display settings.</li> </ul> <p>➤ Your set supports multiscan display functions within the following frequency domain:</p> <p>Horizontal frequency(kHz): 30~ 61          Vertical frequency(Hz): 60~75          Maximum refresh rate (at 60Hz): 1360 X 768</p>
On PC mode, image is not centered on the screen.	<ul style="list-style-type: none"> <li>◆ Adjust the horizontal and vertical position.</li> </ul>

The TFT LCD panel uses a panel consisting of sub pixels (3,147,264) which require sophisticated technology to produce. However, there may be few bright or dark pixels on the screen. These pixels will have no impact on the performance of the product.

## Installing the Wall Mount Kit (LE26R51B, LE26R41B)

➤ *This installation is to be used when attaching the wall mount to a concrete wall. When attaching to other building materials, please contact your nearest dealer.*

### Components (Sold separately)

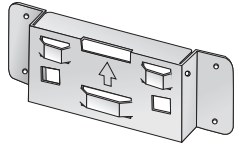

Ⓐ Wall-Bracket

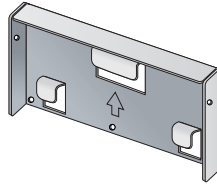

Ⓑ Set-Bracket



M4 X L15

Ⓒ Screw: 8EA



M4 X L20

Ⓓ Wood Screw: 4EA

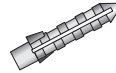

Ⓔ Anchor: 4EA

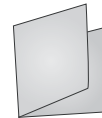

Ⓕ Installation Guide

### How to assemble the Wall Mount Bracket

- 1 ① Mark the location of hole on the wall.
- 2 ② Drill a hole of 35mm depth on the marked location.
- 3 ③ Fix anchors Ⓔ on each hole on the wall.
- 4 ④ Connect wall-bracket Ⓐ to the wall with wood screws Ⓓ after fitting anchors Ⓔ into the wall-bracket Ⓐ.

**Note: If the bracket is not firmly fixed to the wall, LCD TV can fall off.**

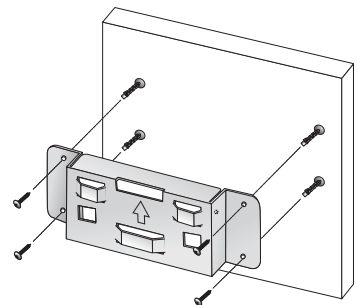

## Installing the Wall Mount Kit (LE26R51B, LE26R41B)

### How to assemble the Wall Mount Bracket

- 2 ① Turn the power off and unplug the power cord from the outlet.
- ② Place the TV faced down on a soft cloth or cushion on a table.
- ③ Remove the four screws from the back of the TV.
- ④ Separate the stand from the TV.
- ⑤ Cover the bottom hole with a cap.
- ⑥ Attach the set-bracket ① onto the rear side of the TV set and secure the screws ②.

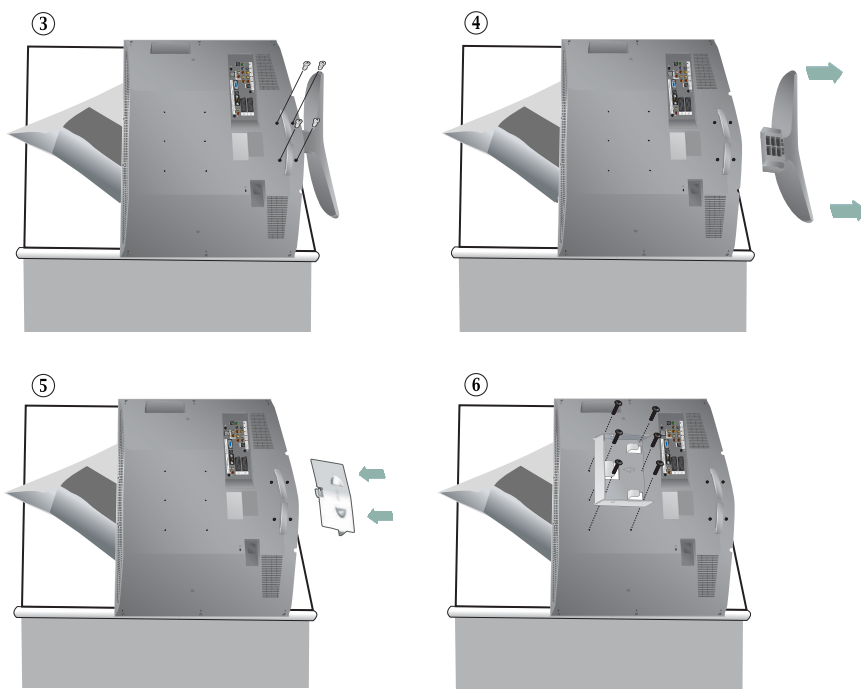

- 3 ① Insert three Hangers of the set-bracket ① into the grooves of the wall-bracket ②.
- ② Fix set-bracket ① and wall-bracket ② with screws ③.

**Note:** Before installing the set on the wall, connect the cables to the set first.

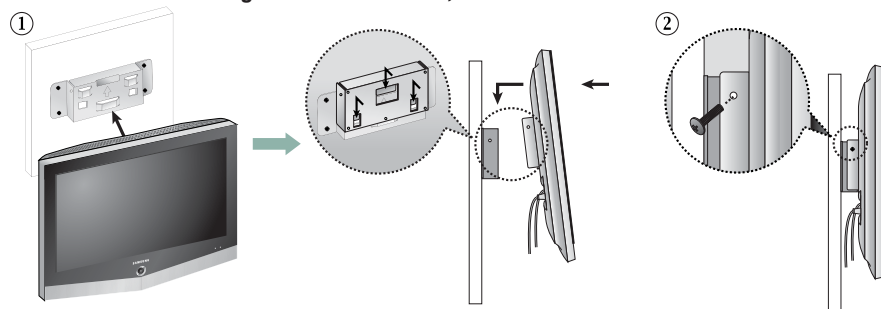

## Installing the Wall Mount Kit (LE32R51B, LE32R52B, LE32R41B, LE40R51B)

➤ *This installation is to be used when attaching the wall mount to a concrete wall. When attaching to other building materials, please contact your nearest dealer.*

### Components (Sold separately)

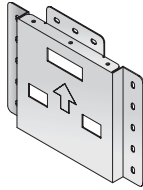

Ⓐ Wall-Bracket

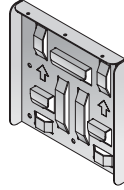

Ⓑ Set-Bracket



M6 X L14

Ⓒ Screw: 8EA



M4 X L25

Ⓓ Wood Screw: 7EA

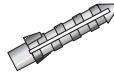

Ⓔ Anchor: 7EA



M4 X L8

Ⓕ Screw: 3EA

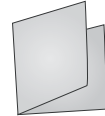

Ⓖ Installation Guide

### How to assemble the Wall Mount Bracket

- 1 ① Mark the location of hole on the wall.
- ② Drill a hole of 35mm depth on the marked location.
- ③ Fix anchors Ⓔ on each hole on the wall.
- ④ Connect wall-bracket Ⓐ to the wall with wood screws Ⓓ after fitting anchors Ⓔ into the wall-bracket Ⓐ.

**Note:** If the bracket is not firmly fixed to the wall, LCD TV can fall off.

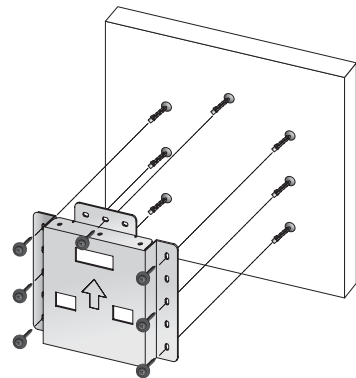

# Installing the Wall Mount Kit (LE32R51B, LE32R52B, LE32R41B, LE40R51B)

## How to assemble the Wall Mount Bracket

- 2 ① Turn the power off and unplug the power cord from the outlet.
- ② Place the TV faced down on a soft cloth or cushion on a table.
- ③ Remove the four screws from the back of the TV.
- ④ Separate the stand from the TV.
- ⑤ Cover the bottom hole with a cap.
- ⑥ Attach the set-bracket ⑥ onto the rear side of the TV set and secure the screws ⑦.

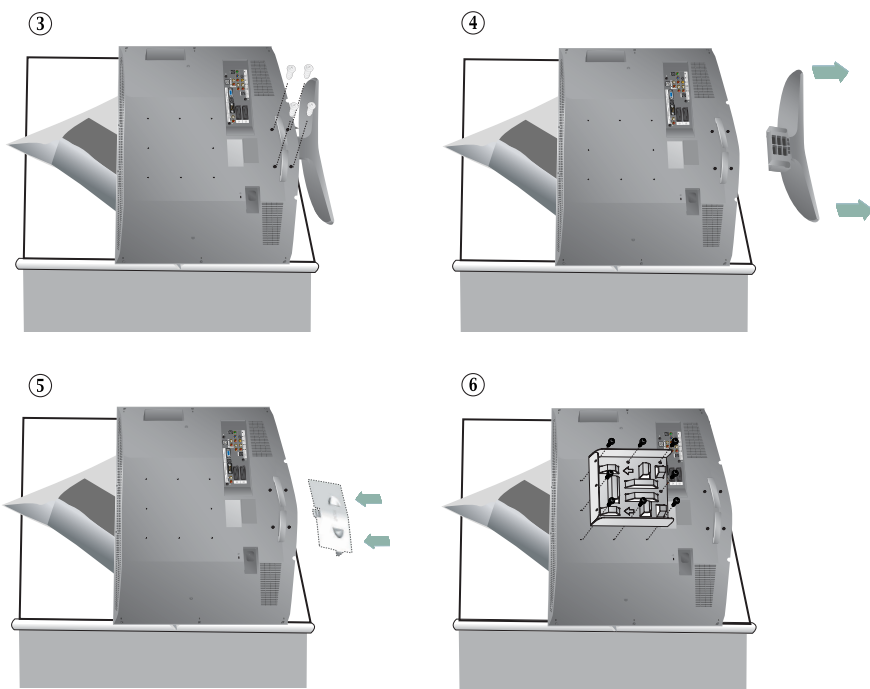

- 3 ① Insert three Hangers of the set-bracket ① into the grooves of the wall-bracket ②.
- ② Fix set-bracket ① and wall-bracket ② with screws ③.

**Note:** Before installing the set on the wall, connect the cables to the set first.

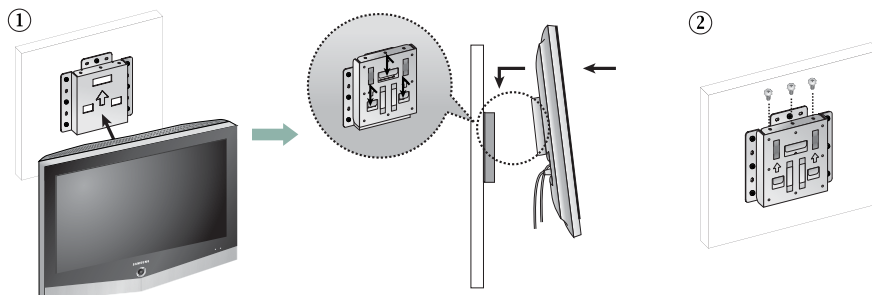

## Installing the Stand (LE26R51B, LE26R41B, LE32R51B, LE32R52B, LE32R41B)

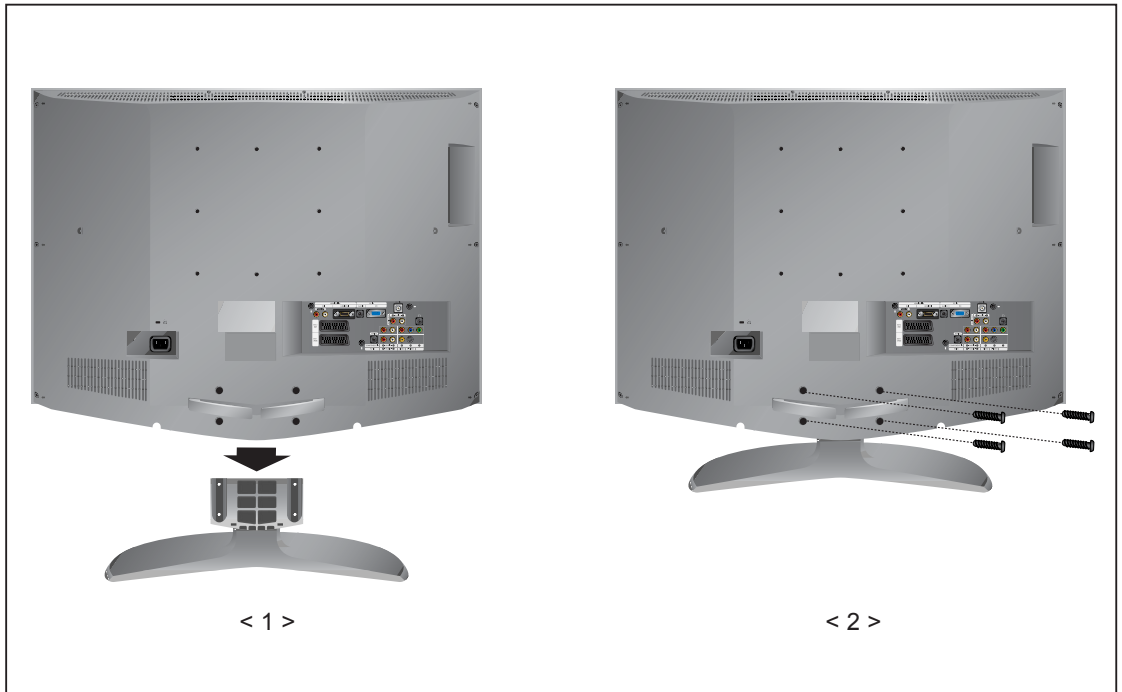

1. Lower the TV set in the direction of the arrow and fix the stand.
2. Use the four screws to tightly fix the stand.

## Using the Anti-Theft Kensington Lock

The Kensington lock is a device used to physically fix the system when using it in a public place. The locking device has to be purchased separately. The appearance and locking method may differ from the illustration depending on the manufacturer. Please refer to the manual provided with the Kensington lock for proper use.

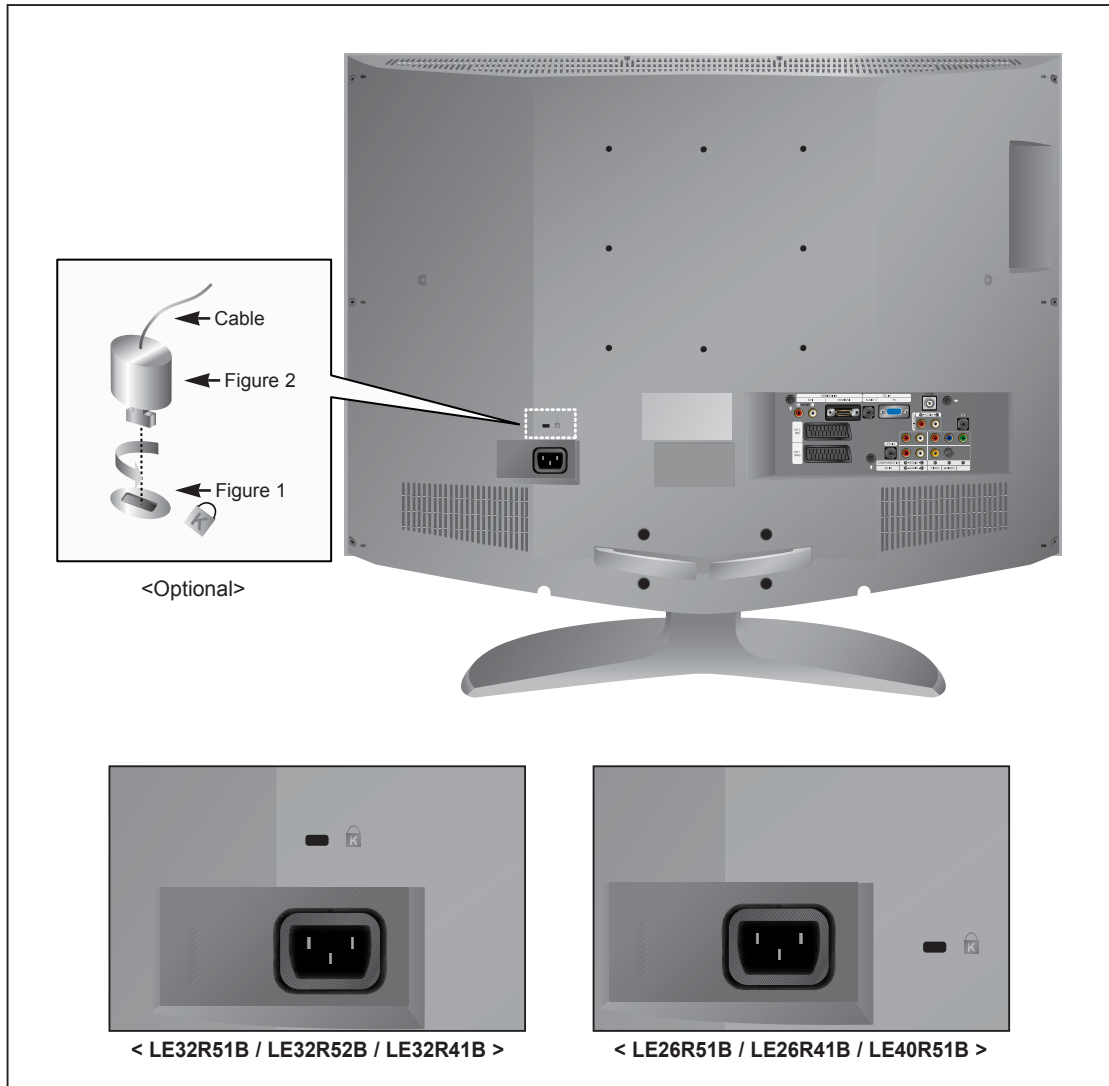

1. Insert the locking device into the Kensington slot on the LCD TV (Figure 1), and turn it in the locking direction (Figure 2).
2. Connect the Kensington lock cable.
3. Fix the Kensington lock to a desk or a heavy stationary object.

# Technical and Environmental Specifications

Model Name	LE26R51B/LE26R41B	LE32R51B/LE32R52B LE32R41B	LE40R51B
<b>Panel</b>			
Size	26" Diagonal (16:9)	32" Diagonal (16:9)	40" Diagonal (16:9)
Display Size	575.77(H) x 323.71(V) mm (22.67(H) x 12.74(V) inches)	697.68 (H) x 392.26 (V) mm (27.47 (H) x 15.44 (V) inches)	885.17 (H) x 497.66 (V) mm (34.85 (H) x 19.59 (V) inches)
Type	a-si TFT active matrix	a-si TFT active matrix	a-si TFT active matrix
Pixel Pitch	0.4215(H) x 0.4215(V) mm (0.0166(H) x 0.0166(V) inches)	0.511 (H) x 0.511 (V) mm (0.0201 (H) x 0.0201(V) inches)	0.648 (H) x 0.216 (V) mm (0.027 (H) x 0.0085 (V) inches)
Viewing Angle	170/170 (H/V)	170/170 (H/V)	170/170 (H/V)
Resolution	1366 (H) x 768 (V)	1366 (H) x 768 (V)	1366 (H) x 768 (V)
<b>Frequency</b>			
Horizontal	30 ~ 61 kHz	30 ~ 61 kHz	30 ~ 61 kHz
Vertical	60 ~ 75 Hz	60 ~ 75 Hz	60 ~ 75 Hz
Display Colour	16,777,216 colours	16,777,216 colours	16,777,216 colours
<b>PC Resolution</b>			
Maximum	1360 x 768 @ 60 Hz	1360 x 768 @ 60Hz	1360 x 768 @ 60Hz
Optimum	1360 x 768 @ 60 Hz	1360 x 768 @ 60 Hz	1360 x 768 @ 60 Hz
<b>Input Signal</b>			
Sync.	H/V Separate, TTL, P. or N.	H/V Separate, TTL, P. or N.	H/V Separate, TTL, P. or N.
Video Signal	0.7 Vp-p @ 75 ohm	0.7 Vp-p @ 75 ohm	0.7 Vp-p @ 75 ohm
<b>TV</b>			
Colour System	PAL, SECAM-B/G, D/K, I, I/I, L/L', NTPB (AV3.58, 4.43)	PAL, SECAM-B/G, D/K, I, I/I, L/L', NTPB (AV3.58, 4.43)	PAL, SECAM-B/G, D/K, I, I/I, L/L', NTPB (AV3.58, 4.43)
Sound System	BG, DK, I, L	BG, DK, I, L	BG, DK, I, L
<b>Video</b>			
Colour System	PAL/NTSC/SECAM	PAL/NTSC/SECAM	PAL/NTSC/SECAM
Video System	CVBS, S-VHS, RGB	CVBS, S-VHS, RGB	CVBS, S-VHS, RGB
<b>SCART 1</b>			
Video Input/Output	1.0 Vp-p @ 75 ohm	1.0 Vp-p @ 75 ohm	1.0 Vp-p @ 75 ohm
RGB Input	0.7 Vp-p @ 75 ohm	0.7 Vp-p @ 75 ohm	0.7 Vp-p @ 75 ohm
Audio Input/Output	500mVrms	500mVrms	500mVrms
<b>SCART 2</b>			
Video Input/Output	1.0 Vp-p @ 75 ohm	1.0 Vp-p @ 75 ohm	1.0 Vp-p @ 75 ohm
Audio Input/Output	500mVrms	500mVrms	500mVrms
<b>Power Supply</b>			
Input	AC 220 ~ 240 V, 60/50 Hz ±3Hz	AC 220 ~ 240 V, 60/50 Hz ±3Hz	AC 220 ~ 240 V, 60/50 Hz ±3Hz
<b>Power Consumption</b>			
Maximum	140 W	184 W	285 W
Power Saving	<1.2 W	< 1 W	< 1 W
<b>Dimension (W x D x H)</b>			
Body	662.0 x 94.0 x 497.8 mm ( 26.06 x 3.70 x 19.598 inches)	797.0 x 99.0 x 592.0 mm (31.38 x 3.898 x 23.31 inches)	989.0 x 333.1 x 762.6 mm (38.94 x 13.11 x 30.02 inches)
With stand	662.0 x 206.0 x 539.0 mm ( 26.06 x 8.11 x 21.22 inches)	797.0 x 249.0 x 650.7 mm (31.38 x 9.80 x 25.62 inches)	989.0 x 110.0 x 702.6 mm (38.94 x 4.33 x 27.66 inches)



## Technical and Environmental Specifications

Model	LE26R51B/LE26R41B	LE32R51B/LE32R52B LE32R41B	LE40R51B
<b>Weight</b> With stand	11.3 kg (24.91 lbs)	17.7 kg (39.02 lbs)	27.2 kg (59.96 lbs)
<b>Environmental Considerations</b> Operating Temperature Operating Humidity Storage Temperature Storage Humidity	10°C to 40°C (50°F to 104°F) 10% to 80%, non-condensing -20°C to 45°C (-4°F to 113°F) 5% to 95%, non-condensing	10°C to 40°C (50°F to 104°F) 10% to 80%, non-condensing -20°C to 45°C (-4°F to 113°F) 5% to 95%, non-condensing	10°C to 40°C (50°F to 104°F) 10% to 80%, non-condensing -20°C to 45°C (-4°F to 113°F) 5% to 95%, non-condensing
<b>Audio Characteristics</b> Audio Input Audio Input (PC) Headphone Output Frequency Response	RCA Jack(L, R), 0.5 Vrms(-9dB) 3.5Ø Stereo Jack, 0.5Vrms (-9dB) Max. 10mW Output (3.5Ø Stereo Jack, 32Ω) RF: 80Hz ~ 15kHz (at -3dB) A/V: 80Hz ~ 20kHz (at -3dB)	RCA Jack (L, R), 0.5Vrms (-9dB) 3.5Ø Stereo Jack, 0.5Vrms (-9dB) Max. 10mW Output (3.5Ø Stereo Jack, 32Ω) RF: 80Hz ~ 15kHz (at -3dB) A/V: 80Hz ~ 20kHz (at -3dB)	RCA Jack (L, R), 0.5Vrms (-9dB) 3.5Ø Stereo Jack, 0.5Vrms (-9dB) Max. 10mW Output (3.5Ø Stereo Jack, 32Ω) RF: 80Hz ~ 15kHz (at -3dB) A/V: 80Hz ~ 20kHz (at -3dB)
<b>Sound</b> Output 3D Surround Stereo	5 W X 2 SRS TruSurroundXT Nicam/A7	10 W X 2 SRS TruSurroundXT Nicam/A3	10 W X 2 SRS TruSurroundXT Nicam/A2

## Display Mode (PC)

*Both screen position and size will vary depending on the type of PC monitor and its resolution.  
The table below shows all of the display modes that are supported:*

Mode	Resolution	Horizontal Frequency (kHz)	Vertical Frequency (Hz)	Pixel Clock Frequency (MHz)	Sync Polarity (H/V)
<b>IBM</b>	640 x 480	31.469	59.940	25.175	- / -
	720 x 400	31.469	70.087	28.322	- / +
<b>VESA</b>	640 x 480	37.861	72.809	31.500	- / -
	640 x 480	37.500	75.000	31.500	- / -
	800 x 600	37.879	60.317	40.000	+ / +
	800 x 600	48.077	72.188	50.000	+ / +
	800 x 600	46.875	75.000	49.500	+ / +
	1024 x 768	48.364	60.000	65.000	- / -
	1024 x 768	56.476	70.069	75.000	- / -
	1024 x 768	60.023	75.029	78.750	+ / +
	1360 x 768	47.712	60.015	85.800	+ / +

- ◆ The interlace mode is not supported.
- ◆ The set might operate abnormally if a non-standard video format is selected.
- ◆ DVI does not support PC function.

# Pin Configurations

## SCART Connector

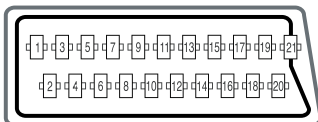

Pin	Signal
1	Audio output R
2	Audio input R
3	Audio output L
4	Audio chassis return
5	Video chassis return (RGB blue)
6	Audio input L
7	RGB blue input
8	Switching voltage
9	Video chassis return (RGB green)
10	AV-Link (Ext 1)
11	RGB green input

Pin	Signal
12	-
13	Video chassis return (RGB red)
14	-
15	RGB red input
16	Blanking signal (RGB switching)
17	Video chassis return
18	Blanking signal ground
19	Video output
20	Video input
21	Screening/chassis return

## PC Input Connector (15Pin)

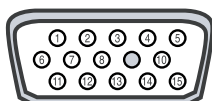

Pin	Signal
1	Red (R)
2	Green (G)
3	Blue (B)
4	Grounding
5	Grounding (DDC)
6	Red (R) Grounding
7	Green (G) Grounding
8	Blue (B) Grounding

Pin	Signal
9	Reserved
10	Sync Grounding
11	Grounding
12	Data (DDC)
13	Horizontal sync.
14	Vertical sync.
15	Clock (DDC)

## Wiring the Mains Power Supply Plug (UK Only)

### ◆ **IMPORTANT NOTICE**

The mains lead on this equipment is supplied with a moulded plug incorporating a fuse. The value of the fuse is indicated on the pin face of the plug and, if it requires replacing, a fuse approved to BSI1362 of the same rating must be used. Never use the plug with the fuse cover omitted if the cover is detachable.

If a replacement fuse cover is required, it must be of the same colour as the pin face of the plug. Replacement covers are available from your dealer. If the fitted plug is not suitable for the power points in your house or the cable is not long enough to reach a power point, you should obtain a suitable safety approved extension lead or consult your dealer for assistance. However, if there is no alternative to cutting off the plug, remove the fuse and then safely dispose of the plug. DO NOT connect the plug to a mains socket as there is a risk of shock hazard from the bared flexible cord.

### ◆ **IMPORTANT**

The wires in the mains lead are coloured in accordance with the following code:

**BLUE - NEUTRAL      BROWN - LIVE**

As these colours may not correspond to the coloured markings identifying the terminals in your plug, proceed as follows:

The wire coloured BLUE must be connected to the terminal marked with the letter N or coloured BLUE or BLACK. The wire coloured BROWN must be connected to the terminal marked with the letter L or coloured BROWN or RED.

**WARNING: DO NOT CONNECT EITHER WIRE TO THE EARTH TERMINAL, WHICH IS MARKED WITH THE LETTER E OR BY THE EARTH SYMBOL, OR COLOURED GREEN OR GREEN AND YELLOW.**

---

## **– AFTER SALES SERVICE**

---

- Do not hesitate to contact your retailer or service agent if a change in the performance of your product indicates that a faulty condition may be present.

